

# **SERVICE MANUAL**

STEREO AMPLIFIER

# **SA-9900**

KCU

 **PIONEER<sup>®</sup>**

# CONTENTS

1. SPECIFICATIONS	3
2. FRONT PANEL FACILITIES	5
3. CONNECTION DIAGRAM	7
4. BLOCK DIAGRAM	9
5. BRIEF DESCRIPTION AND FEATURES OF CIRCUITS	11
6. DISASSEMBLY INSTRUCTIONS	13
7. PARTS LOCATION	18
8. ADJUSTING PROCEDURES FOR JUNCTION POINT AND IDLE CURRENT	20
9. EXPLODED VIEW AND PARTS LIST	22
10. SCHEMATIC DIAGRAMS, P.C. BOARD PATTERNS AND PARTS LIST	
10.1 Schematic Diagram	27
10.2 Electro-Parts	29
10.3 Input Circuit Assembly (AWK-038)	30
10.4 Control Amplifier Assembly (AWG-031)	36
10.5 Power Amplifier Assembly (AWH-037)	40
10.6 Protection Circuit Assembly (AWM-071)	47
10.7 Fuse Board Assembly (AWX-083)	49
10.8 Power Supply Circuit Assembly-1 (AWR-069)	50
10.9 Power Supply Circuit Assembly-2 (AWR-070)	51
10.10 Power Supply Circuit Assembly-3 (AWR-077)	54
10.11 Volume Circuit Assembly (AWX-073)	55
10.12 Tone Switch Circuit Assembly (AWS-079)	56
10.13 Switch Circuit Assembly (AWS-080-0)	62
11. PACKING METHOD	67



# 1. SPECIFICATIONS

## SEMICONDUCTORS

FET(s) .....	10
Transistors .....	74
Diodes .....	33

## POWER AMPLIFIER SECTION

Circuitry ..... 2-stage differential amplifiers. 3-stage Darlington parallel push-pull, pure-complementary OCL.

**110 WATTS\* PER CHANNEL, MIN. RMS, AT 8 OHMS FROM 20Hz to 20kHz, WITH NO MORE THAN 0.1% TOTAL HARMONIC DISTORTION.**

Continuous RMS Power Output

10Hz ~ 20kHz

(Both channels driven) . . . 110W + 110W (4Ω)

1kHz (Both channels driven) . . . 120W + 120W (8Ω)

120W + 120W (4Ω)

Total Harmonic Distortion (20Hz ~ 20kHz)

(Continuous Power Output) . . . . . Less than 0.1%

(55W Power Output, 8Ω) . . . . . Less than 0.04%

(1W Power Output, 8Ω) . . . . . Less than 0.04%

Intermodulation Distortion

(Continuous Power Output) . . . . . Less than 0.1%

(55W Power Output, 8Ω) . . . . . Less than 0.04%

(1W Power Output, 8Ω) . . . . . Less than 0.04%

Power Bandwidth Distortion

(IHF, Both channels driven) . . . . . 5Hz ~ 40kHz (T.H.D. 0.1%)

Frequency Response . . . . . 10Hz ~ 80kHz  $\pm 0$  dB

Input Sensitivity/Impedance

(POWER AMP IN) . . . . . 1V/50kΩ

Output: Speaker . . . . . A, B (4Ω ~ 16Ω)

A + B (8Ω ~ 16Ω)

Headphone . . . . . 4Ω ~ 16Ω

Damping Factor

(20Hz ~ 20kHz, 8Ω) . . . . . More than 30

Hum & Noise (IHF, Short-circuited,

A Network) . . . . . More than 110dB

## PREAMPLIFIER SECTION

Circuitry

Equalizer amplifier . . . . . 3-stage direct-coupled class-A SEPP type with 1st stage FET equipped differential amplifier.

Control amplifier . . . . . 3-stage direct-coupled type with 1st stage FET equipped differential amplifier.

Input Sensitivity/Impedance

PHONO 1 . . . . . 2.5mV/50kΩ

PHONO 2 . . . . . 2.5mV ~ 10mV/35kΩ, 50kΩ, 70kΩ, 100kΩ

MIC . . . . . 6mV ~ 24mV/85kΩ

TUNER . . . . . 150mV/50kΩ

AUX 1 . . . . . 150mV/50kΩ

AUX 2 . . . . . 150mV/50kΩ

TAPE PB 1	150mV/50k $\Omega$
TAPE PB 2	150mV/50k $\Omega$
PHONO Overload Level (T.H.D. 0.1%)	
PHONO 1	500mV (1kHz)
PHONO 2	500mV ~ 1.0V (1kHz)

## Output Level/Impedance

TAPE REC 1	150mV
TAPE REC 2	150mV
PRE OUT	2V/1k $\Omega$

## Harmonic Distortion

(20Hz ~ 20kHz)	Less than 0.05%
----------------	-----------------

## Frequency Response

PHONO (RIAA equalization)	30Hz ~ 15kHz $\pm$ 0.2dB
TUNER, AUX, TAPE PB	7Hz ~ 40kHz $\begin{matrix} +0 \\ -1 \end{matrix}$ dB

## Tone Control (1.5dB step)

BASS	SUB $\pm$ 4.5dB (50Hz)
	MAIN $\pm$ 7.5dB (100Hz)
TREBLE	SUB $\pm$ 4.5dB (20kHz)
	MAIN $\pm$ 7.5dB (10kHz)

## FILTER

LOW	15Hz, 30Hz (12dB/oct.)
HIGH	8kHz, 12kHz (12dB/oct.)

## Hum &amp; Noise (IHF, Short circuited, A Network)

PHONO	More than 70dB
MIC	More than 65dB
TUNER, AUX, TAPE PB	More than 95dB
Attenuator	0, -15dB, -30dB

## MISCELLANEOUS

Power Requirements	AC 120V, 60Hz
Power Consumption	500W
AC Outlets	2(Switched), 1 (Unswitched)
Dimensions	420(W) x 165(H) x 403 (D) mm 16-1/2 x 6-1/2 x 15-7/8 in.
Weight: Without Package	20kg (44 lb 1 oz)
With package	22.4kg (49 lb 6 oz)

## FURNISHED PARTS

Hex. Wrench (used for fasting	
VOLUME knob)	1
Factory Tested Data	1
Operating Instructions	1

\*Measured pursuant to Federal Trade Commission's Trade Regulation rule on Power Output Claims for Amplifiers.

## NOTE:

Specifications and the design subject to possible modification without notice due to improvements.

## 2. FRONT PANEL FACILITIES

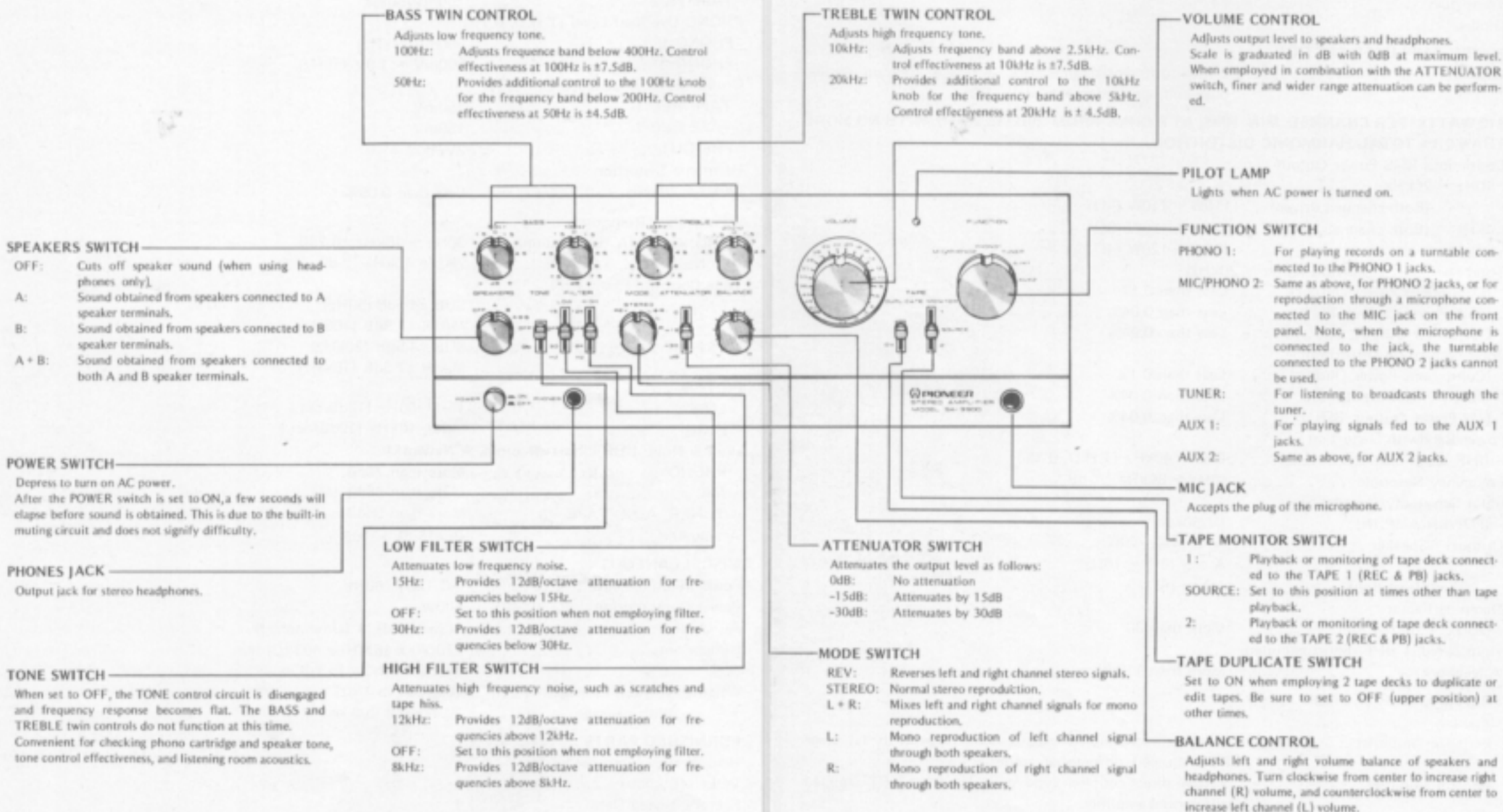

### 3. CONNECTION DIAGRAM

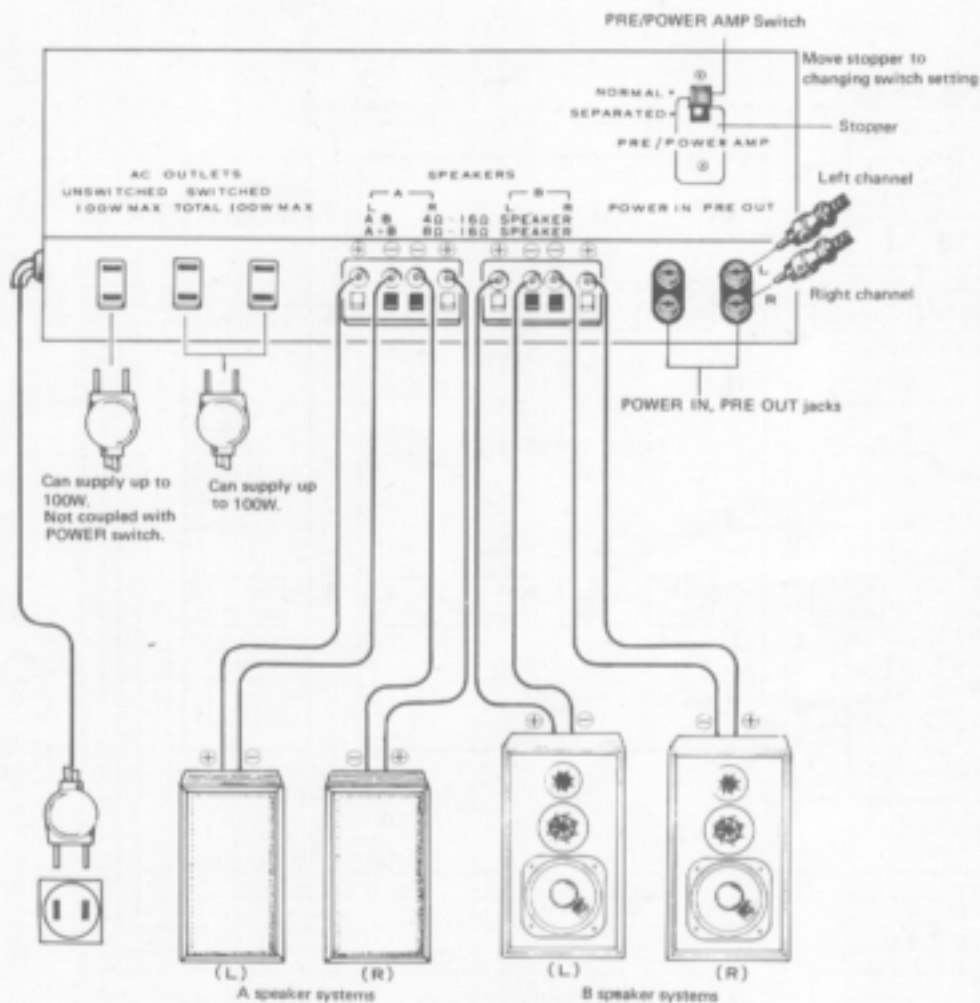

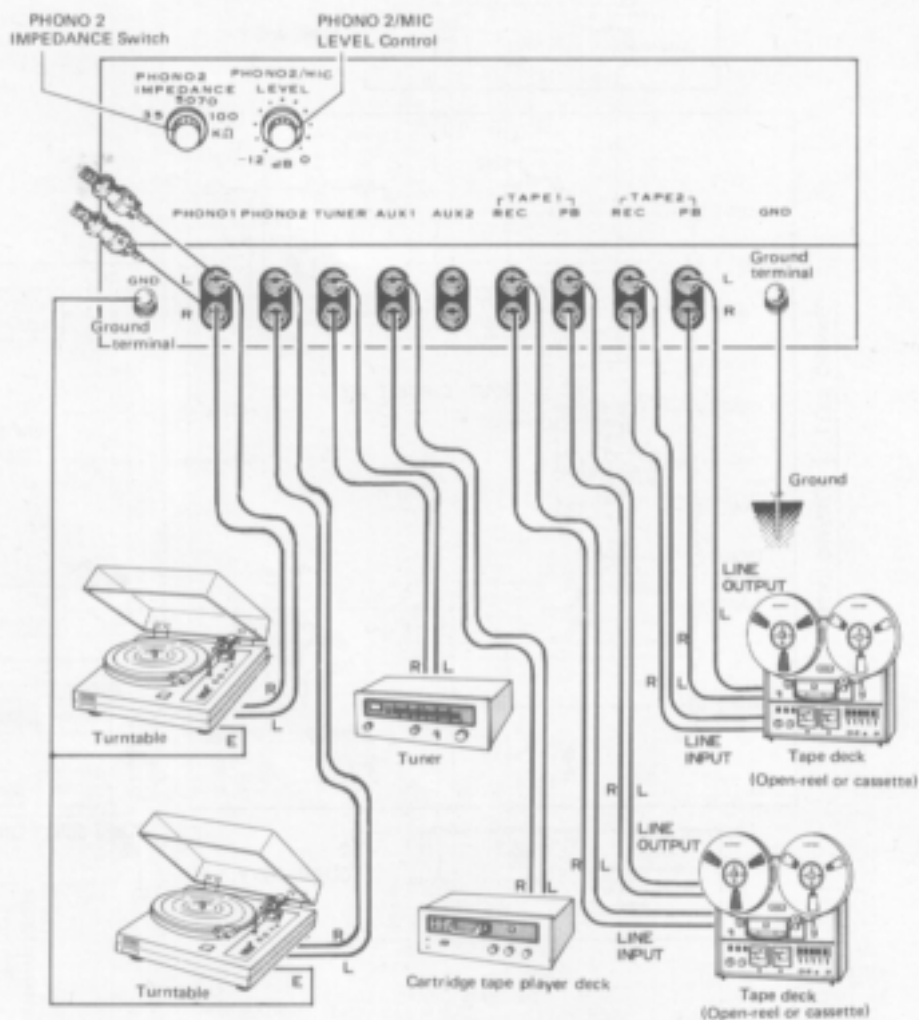

# 4. BLOCK DIAGRAM

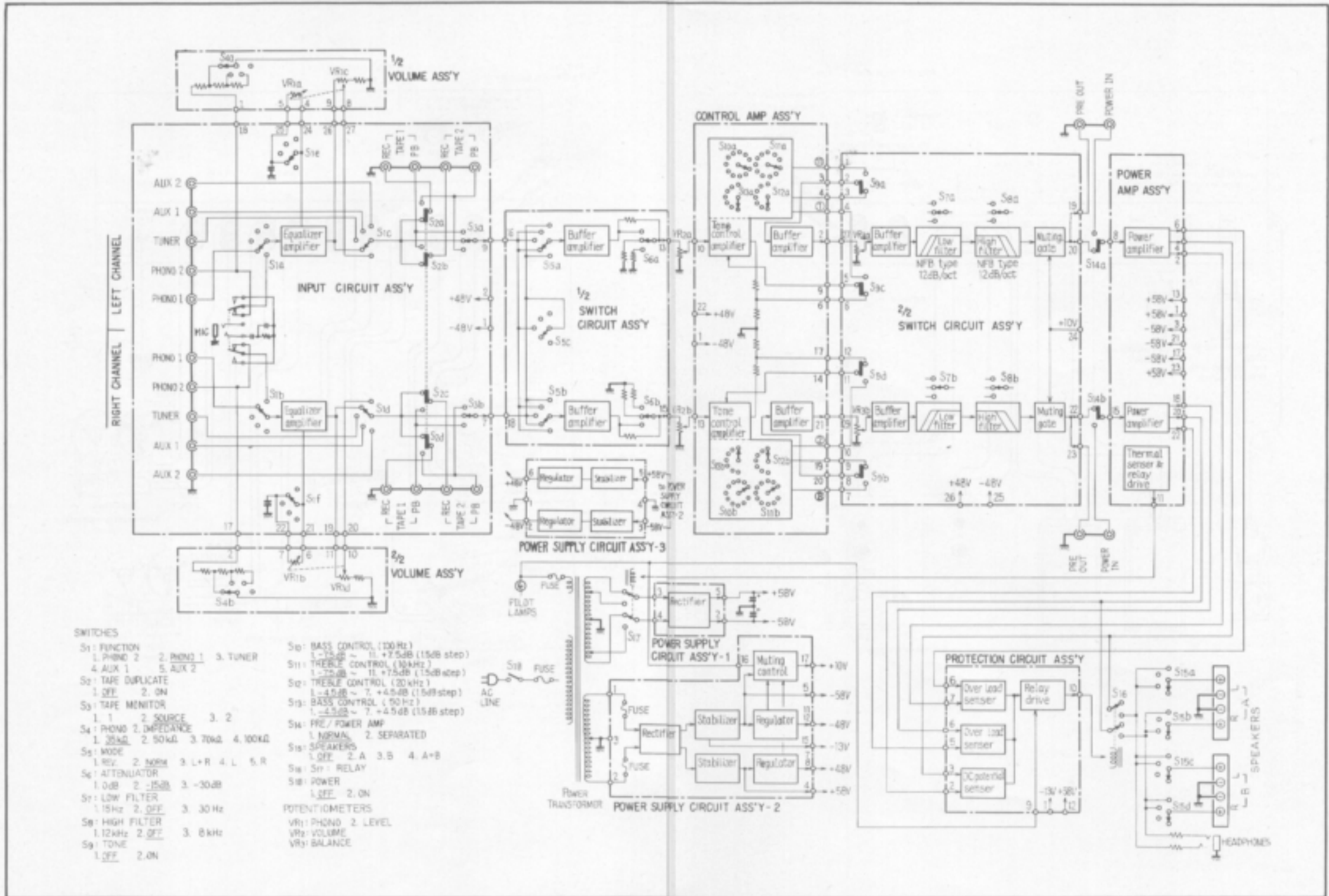



## 5. BRIEF DESCRIPTION AND FEATURES OF CIRCUITS

### Equalizer Amplifier Circuit

The circuit diagram of the equalizer amplifier circuit used in the SA-9900 is shown in Fig. 1. The first stage of this circuit is a differential amplifier consisting of two field-effect transistors (FETs), and the output stage is a single-ended push-pull (SEPP) amplifier which provides a maximum output signal voltage of approximately 29V with a distortion of 1%.

#### (1) Selection of input impedance

If the resistance  $R_1$  in Fig. 1 is infinite, the input impedance of the equalizer amplifier circuit is designed so as to be  $100k\Omega$ .

If the FUNCTION selector switch on the front panel is set to PHONO 1, the resistance of  $R_1$  is  $100k\Omega$ , thus the input impedance of the PHONO 1 terminals becomes  $50k\Omega$ .

If the FUNCTION selector switch is set to PHONO2/MIC, the resistance of  $R_1$  can be selected as  $53.8k\Omega$ ,  $100k\Omega$ ,  $233k\Omega$ , or infinity with the PHONO 2 IMPEDANCE switch on the right-hand side panel.

The input impedance of the PHONO 2 terminals, therefore, can be set to 35, 50, 70 or  $100k\Omega$ .

#### (2) Changing of input sensitivity

The amount of AC signal negative feedback in the equalizer amplifier circuit is determined by the values of the equalizer RC network and resistor  $R_2$ . If the FUNCTION selector switch is set to PHONO 1 the resistance of  $R_2$  is  $1.54k\Omega$ . This was established so that the rated output can be obtained with input signal of 2.5mV at

$1kHz$ . If the FUNCTION selector switch is set to PHONO 2/MIC, the resistance of  $R_2$  can be varied in the range  $1.54 - 3.24k\Omega$  with the PHONO 2/MIC LEVEL control on the right-hand side panel. This permits the input sensitivity to be varied between 2.5 and 5mV. By turning the PHONO 2/MIC LEVEL control, the variable resistor  $VR$  indicated by a dotted line in Fig. 1 also moves. The input sensitivity of the PHONO 2 terminals can therefore be varied throughout the range 2.5 - 10mV.

### Protection Circuit

Fig. 2 is a block diagram of the protection circuit used in the SA-9900. The protection circuit functions to detect DC voltages in the power amplifier output circuit and power transistor overloads and overcurrents, to mute click noise produced by turning the POWER switch ON or OFF, and to prevent abnormal over-heating of the power transistor heat sink. When any of these is detected, the protection circuit operates the relay connected to the power amplifier output circuit to interrupt the speakers. Particularly, for the muting preventing click noise, a fieleffect transistor muting gate is placed on the input side of the power amplifier so that the power amplifier input signal can be interrupted at its input side. This makes sure that the relay contacts turn on or off without sparks because there is no output signal, thus preventing deterioration of the relay contacts and improving the reliability of relay operation.

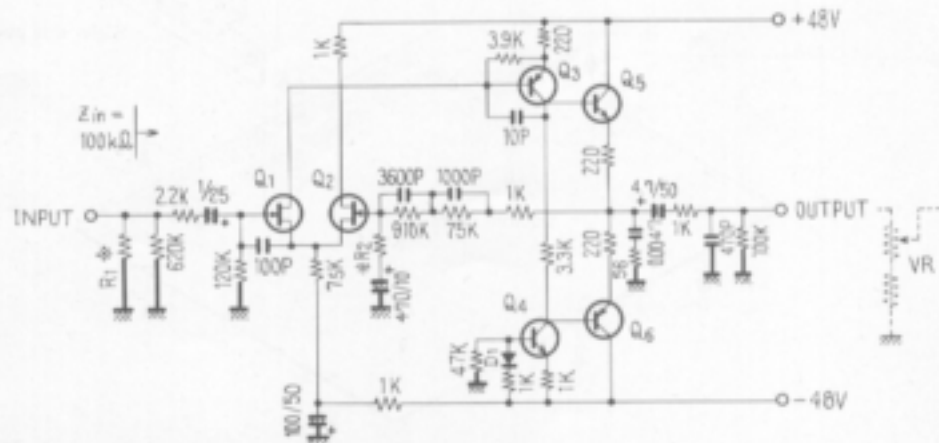

Fig. 1 Circuit Diagram of Equalizer Amplifier

### Heat Sink Over-heating Prevention Circuit

If the SA-9900 is operated continuously at full power with a  $4\Omega$  load, the power transistor heat sink temperature increases greatly. Excessively high heat sink temperature is dangerous if touched, etc., as it is exposed on the rear panel (No problem in practice). For safe handling, this model is provided with a heat sink over-heating prevention circuit which maintains the heat sink temperature below  $85^{\circ}\text{C}$ .

The heat sink temperature is detected by posistors (positive coefficient thermistor), which are placed in the circuit shown in Fig. 3. As shown in the resistance-temperature characteristic (Fig. 4), the posistor resistance hardly changes up to a certain temperature, but increases abruptly at temperatures higher than the temperature specified.

In the over-heating prevention circuit shown in Fig. 3, the posistors serve as the bias circuits for transistors, which operate the relay if the heat sink temperature exceeds the over-heating temperature. The relay, then, changes the power transformer secondary winding tap connections so that the secondary voltage is lowered; thus preventing the heat sink temperature from increasing too much.

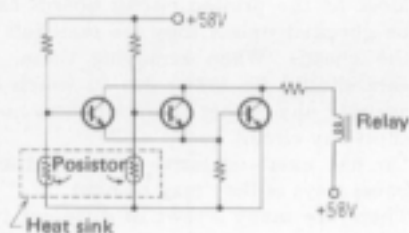

Fig. 3 Diagram of Heat Sink Overheating Preventing Circuit

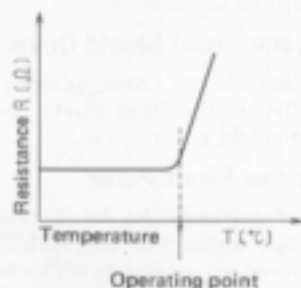

Fig. 4 Posistor Resistance-Temperature Characteristic

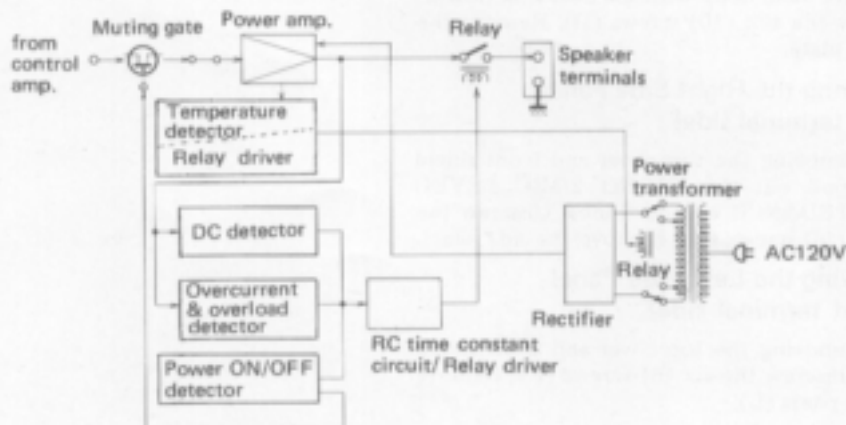

Fig. 2 Block Diagram of Protection Circuit

## 6. DISASSEMBLY INSTRUCTIONS

### Disassembly Cautions

- (1) Great care should be taken in handling the SA-9900/KCU since it is very heavy and the front panel and heat sink fins are exposed.
- (2) When replacing components, be sure to disassemble them in the correct order and to identify the disassembly positions.
- (3) Most of the printed circuit boards cannot be checked unless they are removed from the chassis. When removing them, great care should be taken not to touch them against any other components nor to short any circuit.
- (4) Do not exert excessive force on the side panel stays as they may be bent.
- (5) There are many screws of different types. It is recommended therefore that you make a note of the positions from which they are removed.

### Removing the Top Cover

Unscrew the six (6) screws (A) on the top cover. Lift up the top cover.

### Removing the Front Shield Cover

After removing the top cover, unscrew the two (2) screws (B) on the front shield cover. Lift up the front shield cover.

### Removing the Front Panel

Remove all front panel knobs (C) except the POWER switch knob. For the VOLUME control knob, loosen the set screws with a hexagonal wrench before removing it. Remove the BASS 50Hz, SPEAKERS, and FUNCTION switch shaft nuts and washers. The front panel is ready for removal.

### Removing the Bottom Plate

Stand the main body with the heat sink down. Unscrew the ten (10) screws (D). Remove the bottom plate.

### Removing the Right Side Panel (input terminal side)

After removing the top cover and front shield cover, pull out the PHONO 2/MIC LEVEL and IMPEDANCE control knobs. Unscrew the sixteen (16) screws (E). Remove the side panel.

### Removing the Left Side Panel (output terminal side)

After removing the top cover and front shield cover, unscrew the six (6) screws (F). Remove the side panel (L).

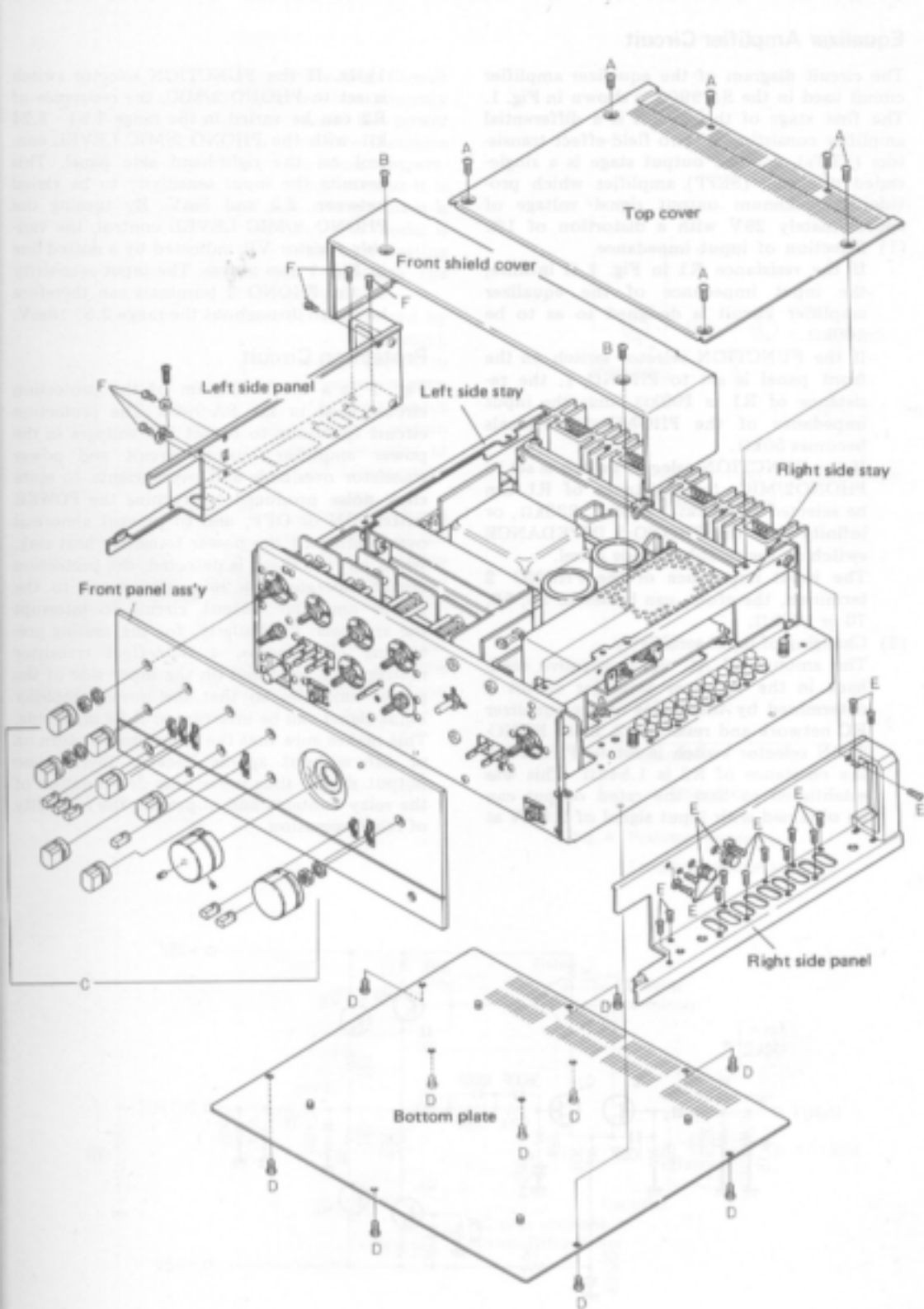

Fig. 5

### Removing the Power Amplifier Printed Circuit Board Assembly (Fig. 6)

- (1) After the top cover and bottom plate have been removed, the power amplifier can be adjusted.
- (2) The power transistors can be replaced by pulling the transistor covers out of the heat sink guides and unscrewing their two screws.
- (3) Unscrew the transistor fixing screws located at the lower part of the center of the heat sink. Loosen the varistor fixing screw at the upper part of the center of the heat sink. Remove the varistor.
- (4) Stand the main body on the bottom plate so it is not touching the bench. Unscrew the eight (8) screws at both sides of the heat sink. This allows the power amplifier printed circuit board to be turned forward.
- (5) Unscrew the four (4) printed circuit board fixing screws and screws A and B. This allows the printed circuit board to be removed from the heat sink. After this has been done amplifier can be checked.

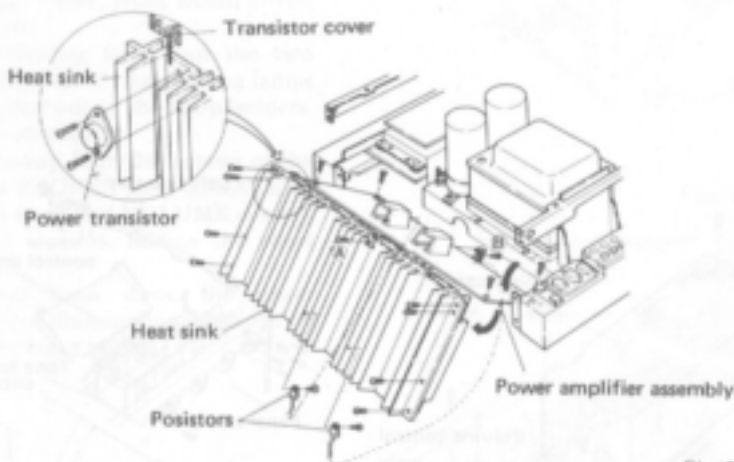

Fig. 6

### Removing the Protection Printed Circuit Board Assembly (Fig. 7)

- (1) Remove the top cover, front shield cover, bottom plate, and left side panel.
- (2) Unscrew the two screws mounting the printed circuit board fixing brackets on the chassis. This permits the printed circuit board to be inclined to an angle depending on the length of the lead wires.

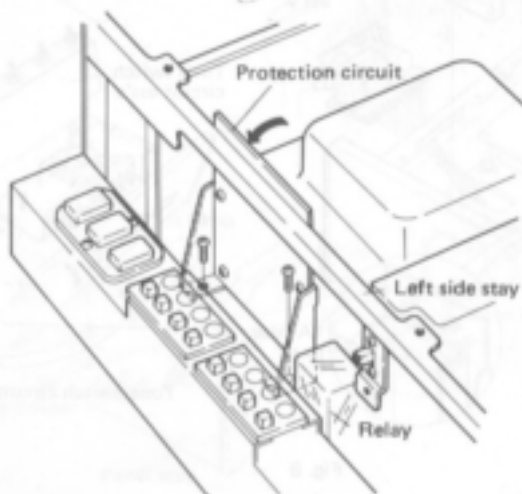

Fig. 7

### Removing the Power Supply Printed Circuit Board Assembly-1 (Fig. 8)

- (1) Remove the top cover, front shield cover, and bottom plate. This allows the 1A protection fuse (F4) in the pilot lamp system to be replaced.
- (2) Unscrew the two (2) screws which mount the printed circuit board on the chassis. This allows the printed circuit board to be moved, though the distance is limited by the length of its lead wire.

### Removing the Power Supply Printed Circuit Board Assembly-2 (Fig. 8)

- (1) Remove the top cover, front shield cover, and right side panel. Remove the shield case. Pull up the printed circuit board from the bosses.
- (2) Be careful not to touch the volume control assembly against any other part.

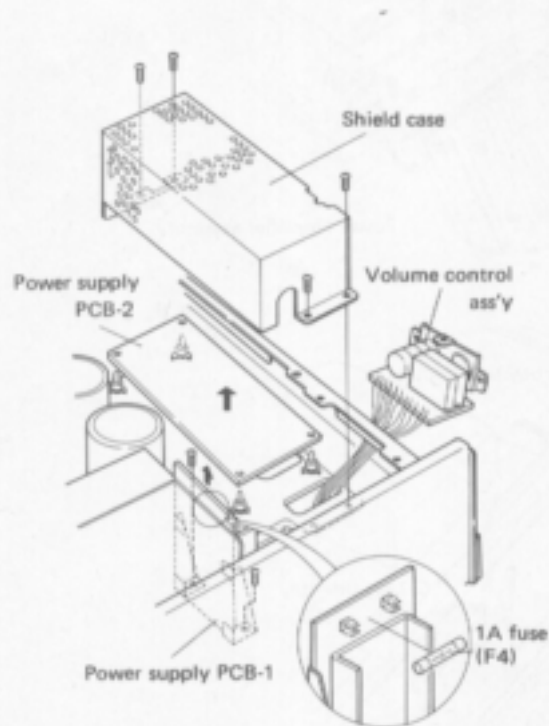

Fig. 8

### Removing the Control Amplifier Printed Circuit Board, Tone Switch Circuit Assembly and Switch Circuit Assembly

- (1) Remove the top cover, front shield cover, front panel, and left side panel.
- (2) Unscrew the three (3) screws which mount the control amplifier printed circuit board shield plate on the chassis. Pull up the shield plate.
- (3) Unscrew the two (2) screws which mount the printed circuit board fixing brackets on the chassis. Lift up the printed circuit board by turning it with its lower end.
- (4) Unscrew the heat sink top screws and two panel stay screws. Remove the left side stay.
- (5) Unscrew the five (5) screws of the panel stay. Remove the tone switch circuit assembly by moving it forward.
- (6) Unscrew the eighteen (18) screws of the panel stay and PHONES jack, SPEAKERS selector switch shaft and VOLUME control shaft nuts and washers. Remove the switch circuit assembly by inclining the panel stay.

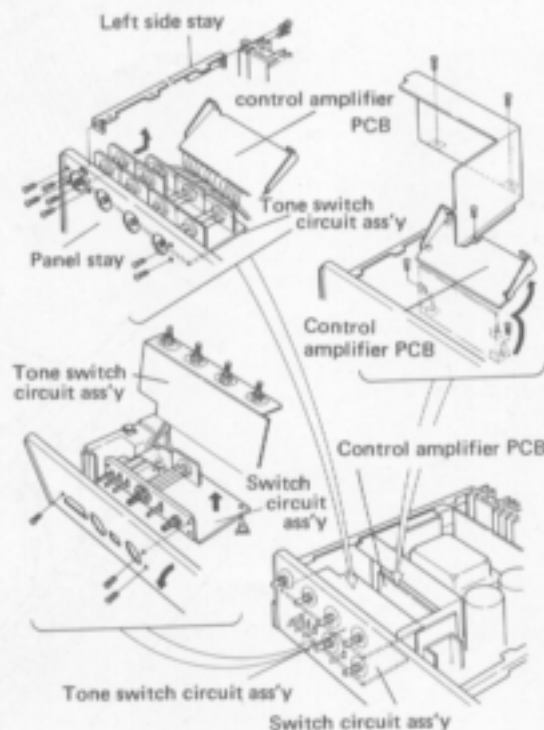

Fig. 9

### Removing the Input Circuit Assembly (Fig. 10)

The PHONO jacks, TAPE MONITOR and DUPLICATE lever switches, and FUNCTION rotary switch are installed on the input circuit assembly printed circuit board.

- (1) Remove the top cover, front shield cover, front panel, bottom plate, and right side panel.
- (2) Remove the shield case and power supply printed circuit board-2.
- (3) Unscrew the twenty four (24) screws of the panel stay and PHONES jack and SPEAKERS selector switch shaft and VOLUME control shaft nuts and washers. Incline the panel stay.
- (4) Pull out the printed circuit board from the bosses.

### Removing the Fuse Board Assembly (Fig. 11)

- (1) Remove the bottom plate.
- (2) Pull out the printed circuit board from the bosses.

### Removing the Pilot Lamps (Fig. 12)

- (1) Remove the top cover, front shield cover, and bottom plate.
- (2) The power indicating lamp and the two upper VOLUME control illuminating lamps can now be pulled out of the lamp holders.
- (3) Remove the front panel.
- (4) Unscrew the twenty four (24) screws of the panel stay and PHONES jack, SPEAKERS selector switch shaft and VOLUME control shaft nuts and washers. Incline the panel stay to the front.
- (5) When this has been done the lower VOLUME control illuminating lamp can be pulled out of its lamp holder.

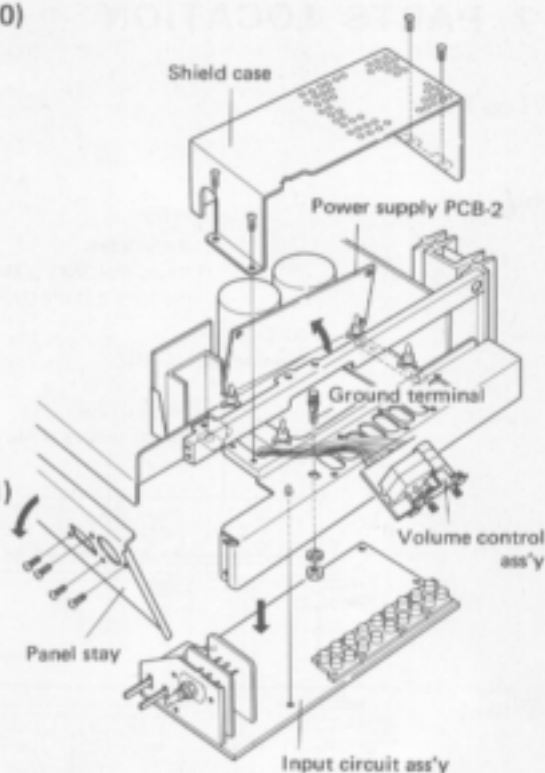

Fig. 10

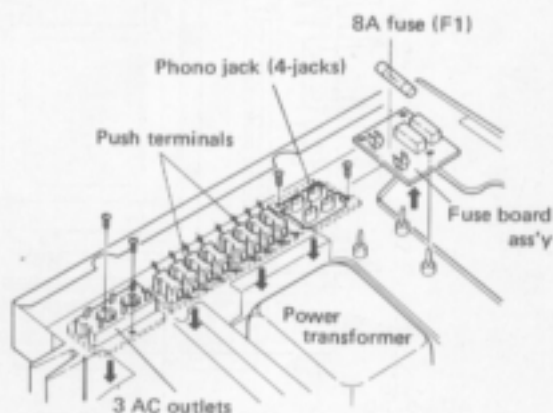

Fig. 11

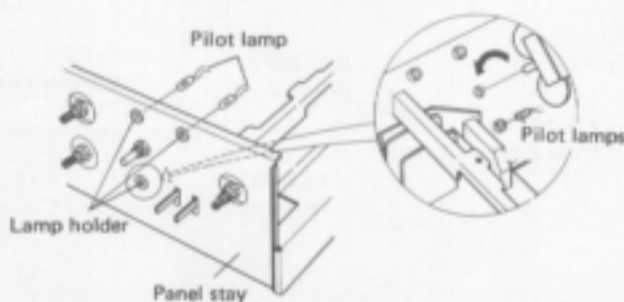
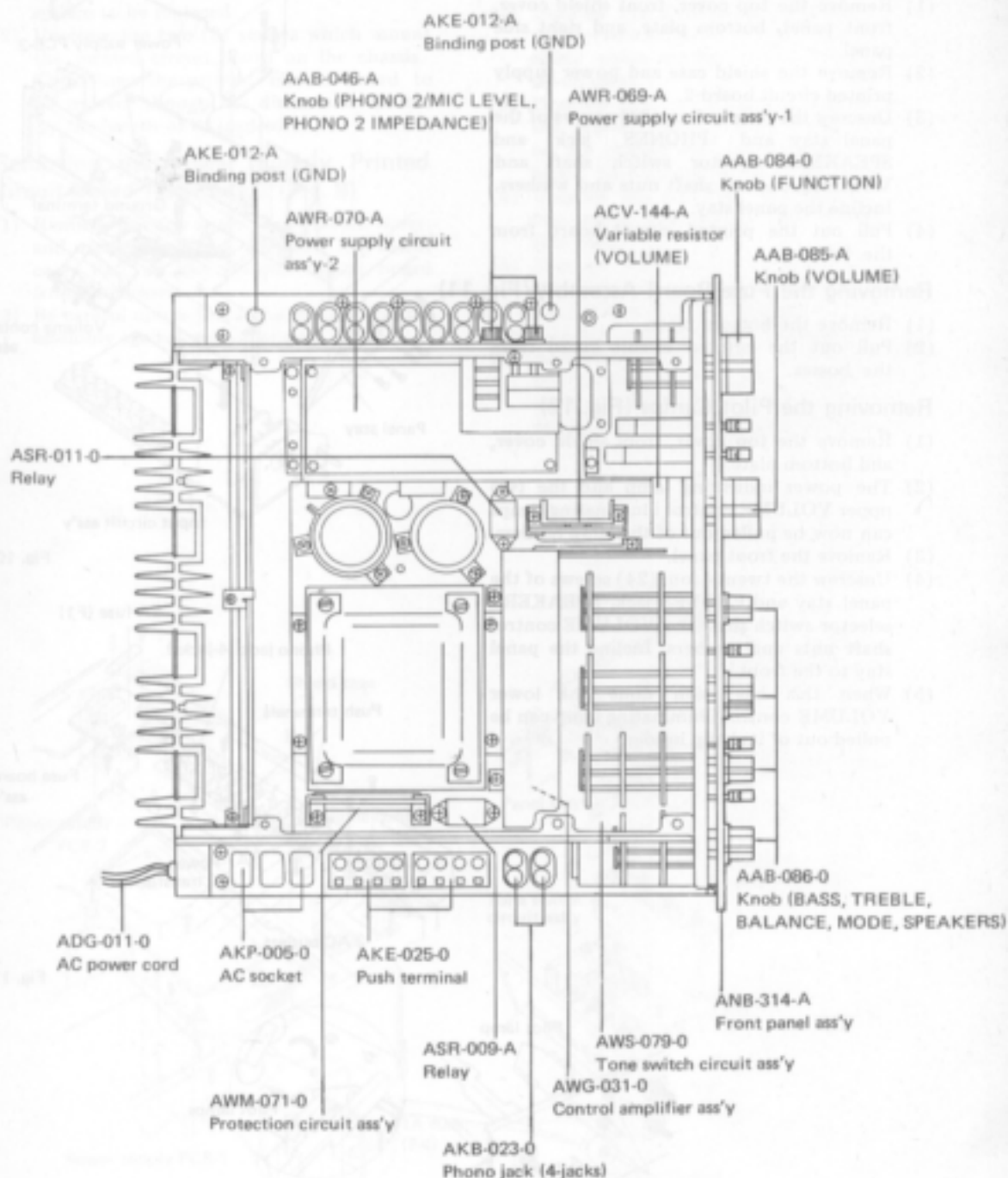

Fig. 12

## 7. PARTS LOCATION

### Top View





## Bottom View

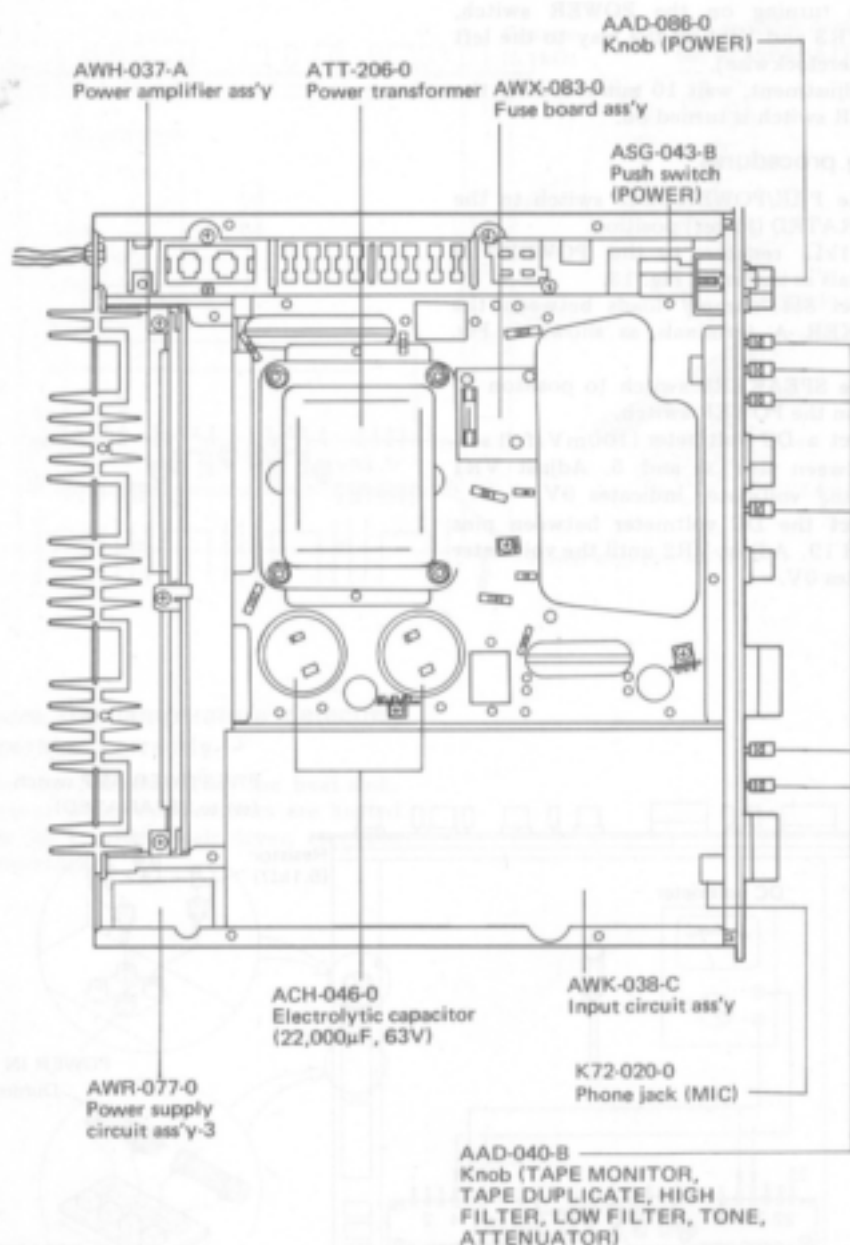

## 8. ADJUSTING PROCEDURES FOR JUNCTION POINT AND IDLE CURRENT

### Set-up

- (a) Remove the top cover and bottom plate, and stand the main body with the heat sinks down.
- (b) Before turning on the POWER switch, turn VR3 and VR4 all the way to the left (counterclockwise).
- (c) For adjustment, wait 10 minutes after the POWER switch is turned on.

### Adjusting procedures

- (1) Set the PRE/POWER AMP switch to the SEPARATED (lower) position.
- (2) Fit  $5.1\text{k}\Omega$  resistors to the POWER IN terminals as shown in Fig. 13.
- (3) Connect  $8\Omega$  dummy loads between the SPEAKER A terminals as shown in Fig. 13.
- (4) Set the SPEAKERS switch to position A. Turn on the POWER switch.
- (5) Connect a DC voltmeter (100mV/full scale) between pins 4 and 5. Adjust VR1 until the voltmeter indicates 0V.
- (6) Connect the DC voltmeter between pins 20 and 19. Adjust VR2 until the voltmeter indicates 0V.

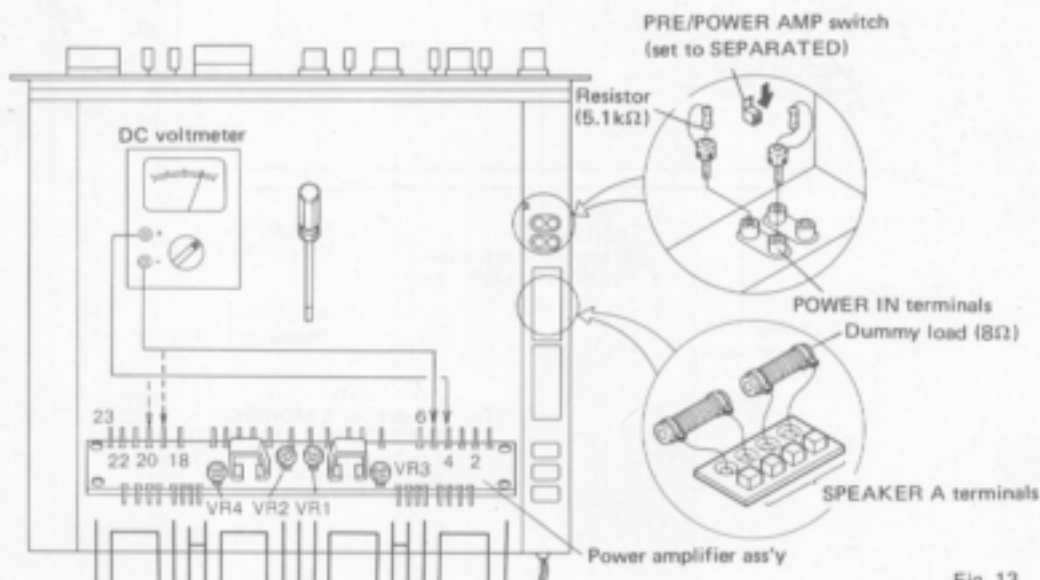

Fig. 13

- (7) Connect the DC voltmeter between pins 2 and 6. Adjust VR3 until the voltmeter indicates 50mV.
- (8) Connect the DC voltmeter between pins 18 and 22. Adjust VR4 until the voltmeter indicates 50mV.

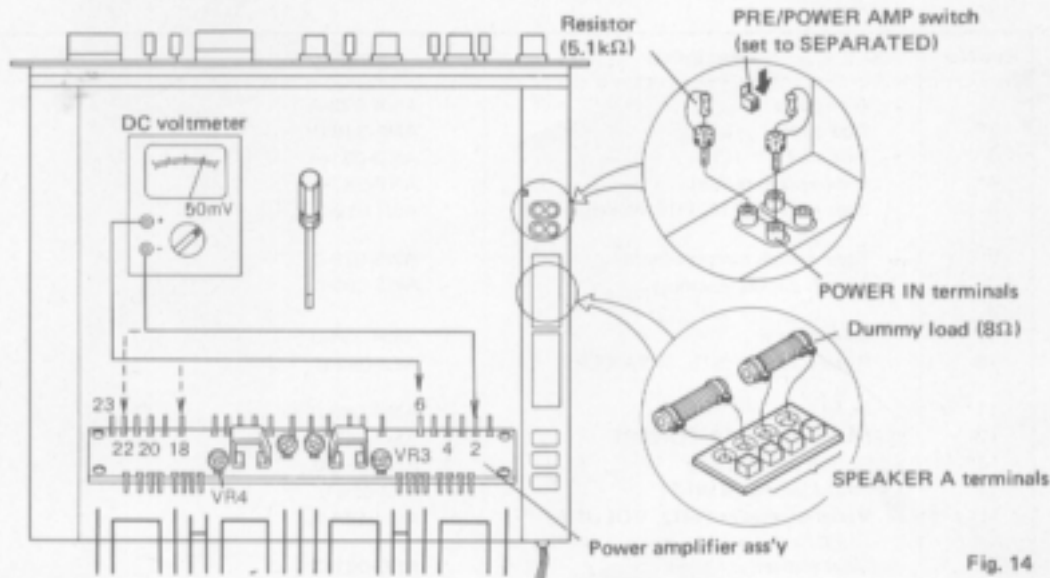

Fig. 14

### Making sure the temperature detecting circuit operates correctly

- (1) Remove the pistons from the heat sink.
- (2) Check that when the pistons are heated to over 85°C with a hair dryer, etc., the relay operates.

## 9. EXPLODED VIEW AND PARTS LIST

### NOTE:

Parts number is subject to change for the purpose of improvement with notice of a service bulletin.

Service bulletin will be furnished whenever necessary and you are requested to amend parts number in this manual according to the instructions.

### Parts List of Exploded View

NOTICE: Any parts asterisked (\*) are subject to being not supplied.

Key No.	Description	Part No.
1	Wire guide	ANK-073-A
2*	Side panel (L)	ANB-316-0
3*	Side stay (L)	AND-081-A
4*	Slide switch mount	ANF-287-0
5	Slide switch (S14, PRE/POWER AMP)	ASH-012-0
6	Tone switch circuit assembly	AWS-079-0
7	Switch circuit assembly	AWS-080-0
8		
9*	Shield cover	ANH-234-0
10	Rotary switch (S15, SPEAKERS)	ASB-047-0
11*	Panel stay	AND-086-0
12	Push switch (S18, POWER)	ASG-043-B
13*	Switch mount plate	ANF-289-0
14	Phone jack (PHONES)	K72-026-0
15	Variable resistor (VR2, VOLUME)	ACV-144-A
16	Claw washer	ABE-001-0
17	Special nut	ABN-009-0
18	Nut (9φ)	B71-004-0
19*	Lamp holder	AEB-051-A
20	Lamp (with leads, PL1, 8V 50mA)	AEL-022-0
21	Front panel assembly	ANB-314-A
22	Washer (t = 1mm)	M45-086-A
23	Nut (9φ)	B71-004-0
24	Knob (BASS-50Hz, BASS-100Hz, TREBLE-10kHz, TREBLE-20kHz, SPEAKERS, MODE, BALANCE)	AAB-086-0
25	Knob (TONE, LOW FILTER, HIGH FILTER, ATTENUATOR, TAPE MONITOR, TAPE DUPLICATE)	AAD-040-B
26	Knob (POWER)	AAD-086-0
27	Knob (VOLUME)	AAB-085-A
28	Knob (FUNCTION)	AAB-084-0
29	Power transformer	ATT-206-0
30*	Shield cover	ANH-233-A
31	Control amplifier assembly	AWG-031-0
32	Protection circuit assembly	AWM-071-0
33*	Sub-chassis	ANF-290-0
34	Power supply circuit assembly-1	AWR-069-A
35	Cover, AC outlet	AEC-181-0
36	AC socket	AKP-005-0
37	Push terminal (SPEAKERS)	AKE-025-0
38	Relay (S16)	ASR-009-A

Note: Any parts asterisked (\*) are subject to being not supplied.

Key No.	Description	Part No.	
39	Cover, phono jack	AEC-182-0	
40	Phono jack (4-jacks, RCA type)	AKB-023-0	
41*	Chassis (L)	ANA-077-B	
42*	Wire clip (A)	AEC-009-0	
43*	Chassis (C)	ANA-075-B	
44*	Wire clip (D)	AEC-024-0	
45*	Boss	AEC-183-0	
46	Fuse board assembly	AWX-083-0	
47	Ground terminal 2P	K13-048-0	
48*	Chassis (R)	ANA-076-A	
49	Input circuit assembly	AWK-038-C	
50	Binding post (GND)	AKE-012-A	
51	Claw washer	ABE-006-0	
52	Nut (7φ)	B71-010-0	
53*	Side panel (R)	ANB-315-0	
54	Knob (PHONO 2 LEVEL, IMPEDANCE)	AAB-046-A	
55	Electrolytic capacitor 22,000μF 63V (C1, C2)	ACH-046-0	
56*	Front shield cover	ANH-231-A	
57	Top cover	ANE-072-A	
58*	Shield cover	ANH-232-0	
59	Fuse 1A (F4, lamp)	AEK-106-0	
60	Fuse 1A (F2, F3, secondary)	AEK-106-0	
61	Power supply circuit assembly-2	AWR-070-A	
62	Volume circuit assembly	AWX-073-A	
63	Cover, power transistor	ANE-073-B	
64*	Power amplifier block		Refer to P.24
65*	Side stay (R)	AND-080-A	
66*	Bottom plate	ANE-071-A	
67	Foot assembly	AEC-178-0	
68	Ground terminal 4P	K13-047-0	
69	Fuse BA (F1, primary)	AEK-300-0	
70	Cord grommet	AEC-079-0	
71	AC power cord	ADG-011-0	
72*	Shield plate	ANH-247-0	
73*	Wire clip (S)	AEC-037-0	
74*	Lock plate	AEC-193-0	
75*	P.C. board mount metal	ANF-309-A	
76	Power supply circuit assembly-3	AWR-077-0	
77	Nut (insulator)	AEC-085-0	
78	Phono jack (MIC)	K72-020-0	
79	Washer (insulator)	E32-045-A	
80	Washer (insulator)	E34-004-0	
81	Relay (S17)	ASR-011-0	
82	Tapping screw 4XB	ABA-079-A	
83	Tapping screw 4X12	ABA-083-0	

# Key No. 64 Power Amplifier Block

NOTICE: Any parts asterisked (\*) are subject to being not supplied.

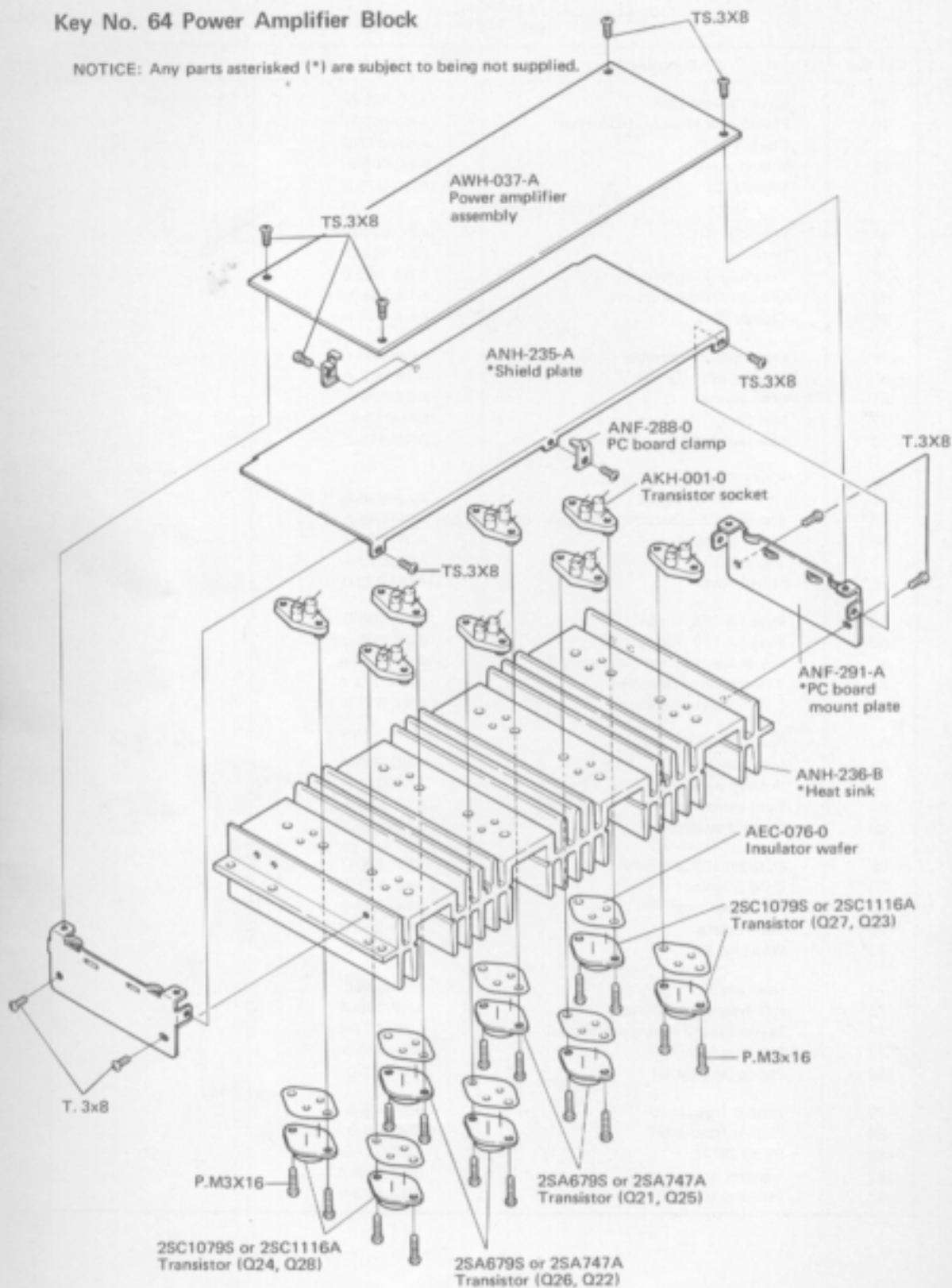

Exploded View

Screws

P: Pan head

B: Binding head

T: Tapping screw (Fig. A)

TS: Tapping screw (Fig. B)

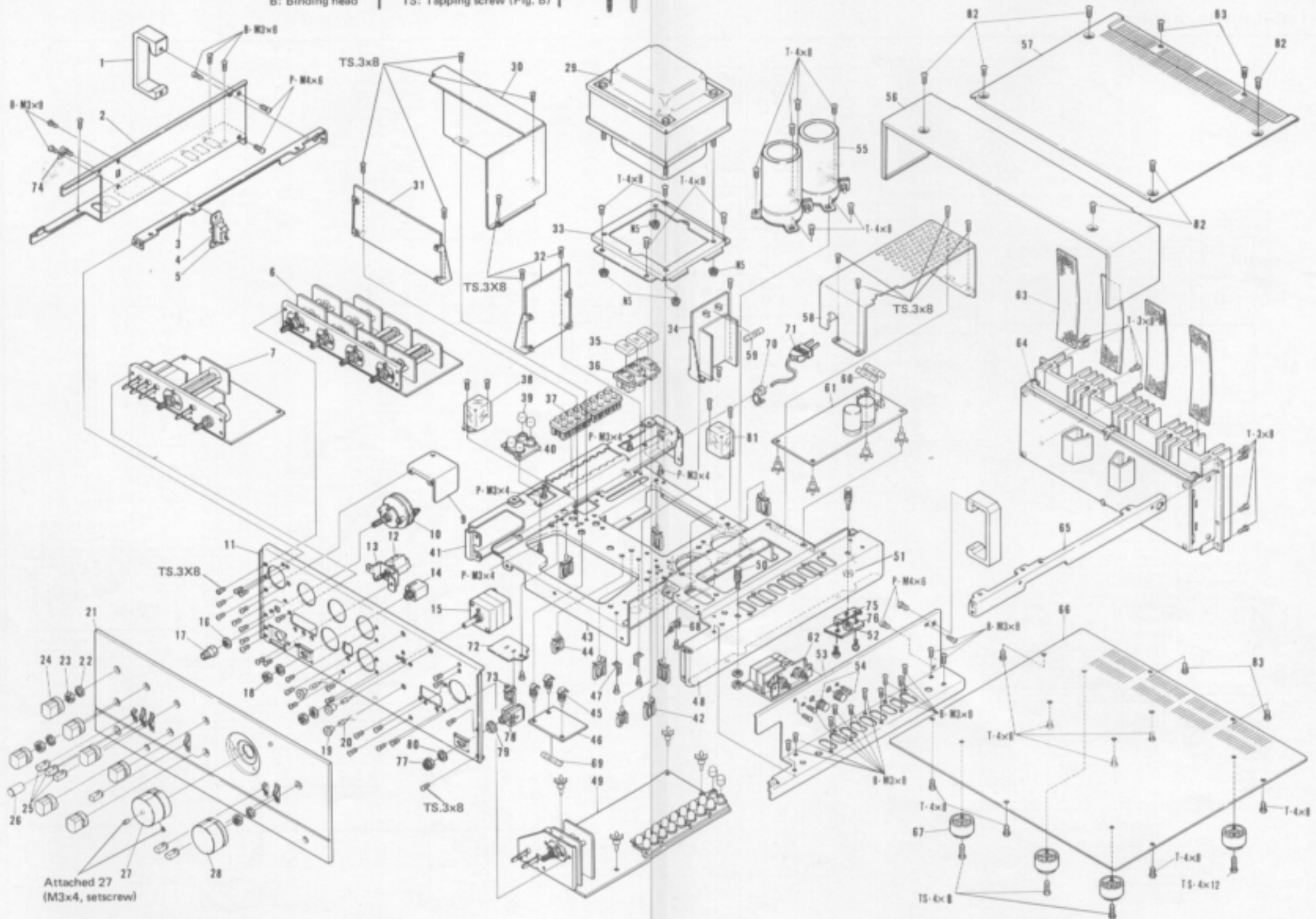

# 10. SCHEMATIC DIAGRAMS, P.C.BOARD PATTERNS AND PARTS LIST

## 10.1 SCHEMATIC DIAGRAM

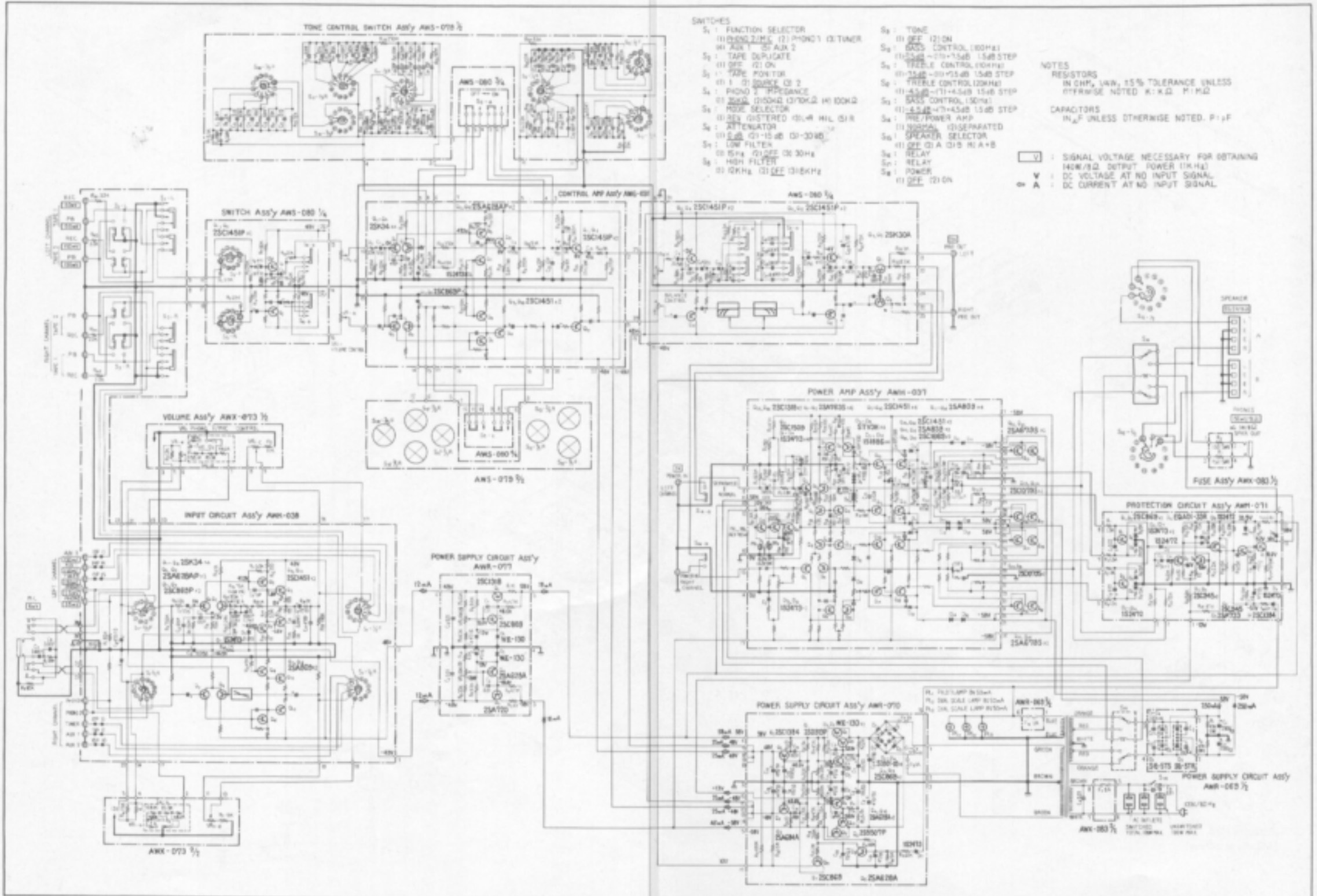



## 10.2 ELECTRO-PARTS

## CAPACITORS

Symbol	Description	Part No.
C1	Electrolytic 22,000 63V	ACH-046-0
C2	Electrolytic 22,000 63V	ACH-046-0
C3	Ceramic 0,01 250V	ACG-001-0
C4	Ceramic 0,01 AC 150V/DC 1.4kV	ACG-003-0
C5	Mylar 0.0047 50V	CQMA 472K 50
C6	Mylar 0.0027 50V	CQMA 272K 50

## RESISTORS

Symbol	Description	Part No.
R1	Metal oxide film 4.7k 2W	RS2P 472J
R2	Metal oxide film 4.7k 2W	RS2P 472J
R3	Carbon film 39k	RD%PS 393J
R4	Carbon film 82k	RD%PS 823J
VR2	Variable resistor 50k (VOLUME)	ACV-144-A

## SEMICONDUCTORS

Symbol	Description	Part No.
Q21	Transistor 2SA679S-Y or R (2SA747A-R, O or Y)	
Q22	Transistor 2SA679S-Y or R (2SA747A-R, O or Y)	
Q23	Transistor 2SC1079S-Y or R (2SC1116A-R, O or Y)	
Q24	Transistor 2SC1079S-Y or R (2SC1116A-R, O or Y)	
Q25	Transistor 2SA679S-Y or R (2SA747A-R, O or Y)	
Q26	Transistor 2SA679S-Y or R (2SA747A-R, O or Y)	
Q27	Transistor 2SC1079S-Y or R (2SC1116A-R, O or Y)	
Q28	Transistor 2SC1079S-Y or R (2SC1116A-R, O or Y)	

## OTHERS

Symbol	Description	Part No.
T1	Power transformer	ATT-206-0
S14	Slide switch (PRE/POWER AMP)	ASH-012-0
S15	Rotary switch (SPEAKERS)	ASB-047-0
S16	Relay	ASR-009-A
S17	Relay	ASR-011-0
S18	Push switch (POWER)	ASG-043-B
F1	Fuse 8A (primary)	AEK-300-0
F2	Fuse 1A (secondary)	AEK-106-0
F3	Fuse 1A (secondary)	AEK-106-0
F4	Fuse 1A (lamp)	AEK-106-0
PL1	Lamp, 8V 50mA, with leads (pilot)	AEL-022-0
PL2	Lamp, 8V 50mA, with leads (scale)	AEL-022-0
PL3	Lamp, 8V 50mA, with leads (scale)	AEL-022-0

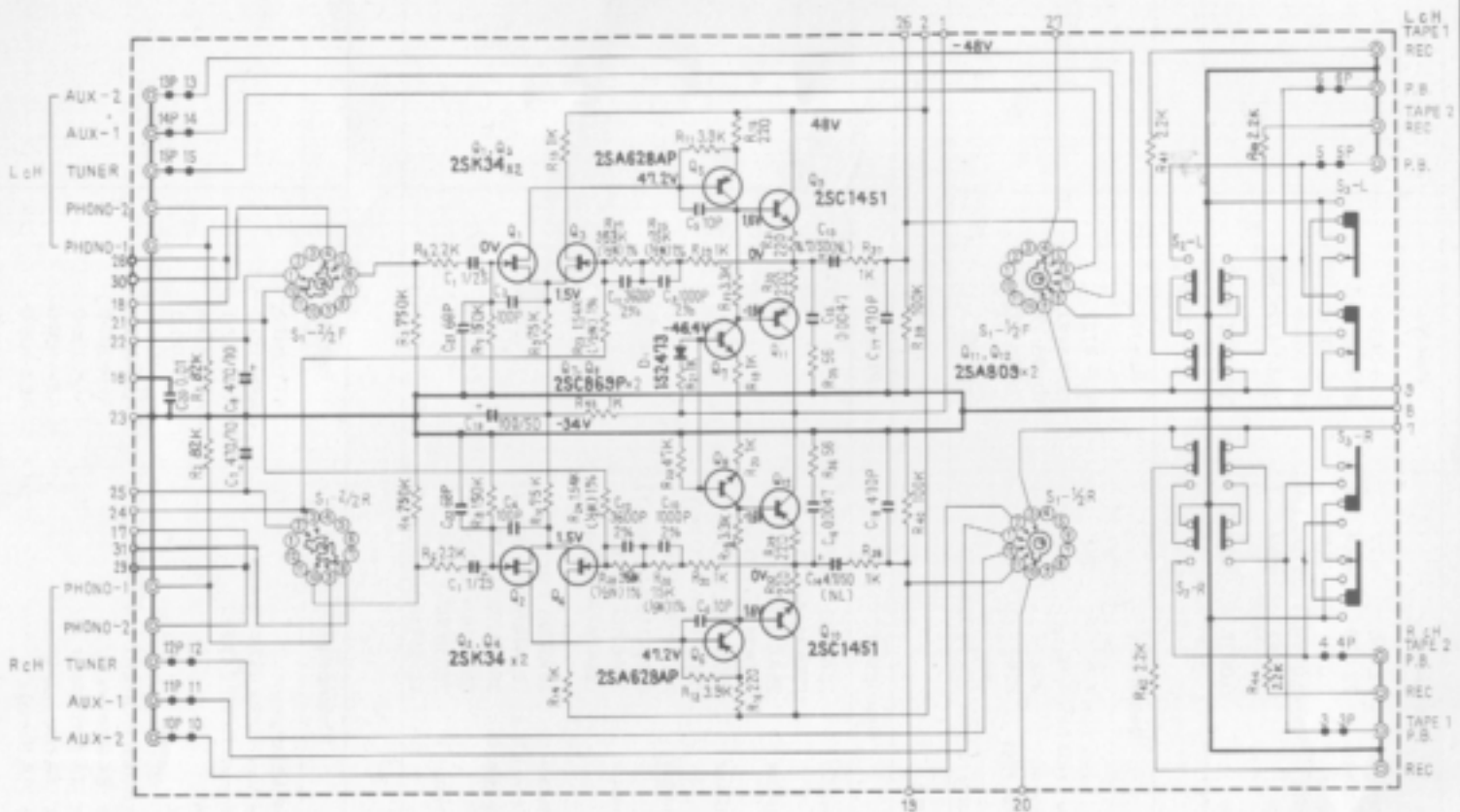

SWITCHES

- |                         |                               |
|-------------------------|-------------------------------|
| S <sub>1</sub> FUNCTION | S <sub>2</sub> TAPE DUPLICATE |
| 1. PHONO 2              | 1. OFF                        |
| 2. PHONO 1              | 2. ON                         |
| 3. TUNER                | S <sub>3</sub> TAPE MONITOR   |
| 4. AUX 1                | 1. 1                          |
| 5. AUX 2                | 2. SOURCE                     |
|                         | 3. 2                          |

Foil Side

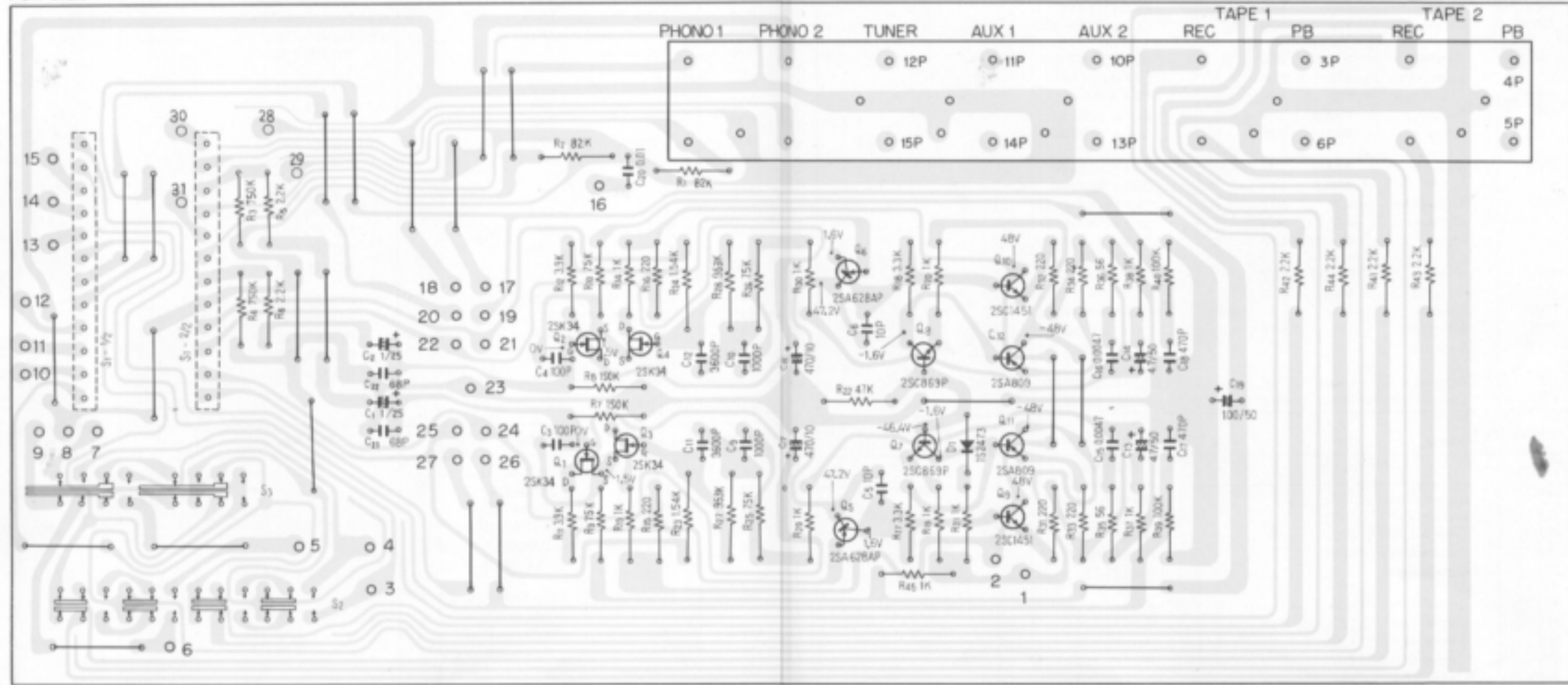

2SK34



2SA628AP  
2SC869P



2SA809  
2SC1451



(2SA763UL)



## Parts List of Input Circuit Assembly (AWK-038-C)

### CAPACITORS

Symbol	Description			Part No.
C1	Electrolytic	1	25V	CSZA 010M 25
C2	Electrolytic	1	25V	CSZA 010M 25
C3	Ceramic	100p	50V	CKDYB 101K 50
C4	Ceramic	100p	50V	CKDYB 101K 50
C5	Ceramic	10p	50V	CCDSL 100F 50
C6	Ceramic	10p	50V	CCDSL 100F 50
C7	Electrolytic	470	10V	CEA 471P 10
C8	Electrolytic	470	10V	CEA 471P 10
C9	Styrol	1000p	50V	CQSA 102G 50
C10	Styrol	1000p	50V	CQSA 102G 50
C11	Styrol	3600p	50V	CQSA 362G 50
C12	Styrol	3600p	50V	CQSA 362G 50
C13	Electrolytic	4.7	50V	CEANL 4R7P 50
C14	Electrolytic	4.7	50V	CEANL 4R7P 50
C15	Mylar	0.0047	50V	COMA 472J 50
C16	Mylar	0.0047	50V	COMA 472J 50
C17	Ceramic	470p	50V	CKDYB 471K 50
C18	Ceramic	470p	50V	CKDYB 471K 50
C19	Electrolytic	100	50V	CEA 101P 50
C20	Ceramic	0.01	50V	CKDYB 103K 50
C21	Ceramic	68p	50V	CCDSL 680K 50
C22	Ceramic	68p	50V	CCDSL 680K 50

### RESISTORS

Symbol	Description			Part No.
R1	Carbon film	100k		RD%PS 104J
R2	Carbon film	100k		RD%PS 104J
R3	Carbon film	620k		RD%PS 624J
R4	Carbon film	620k		RD%PS 624J
R5	Carbon film	2.2k		RD%PS 222J
R6	Carbon film	2.2k		RD%PS 222J
R7	Carbon film	120k		RD%PS 124J
R8	Carbon film	120k		RD%PS 124J
R9	Carbon film	75k		RD%PS 753J
R10	Carbon film	75k		RD%PS 753J
R11	Carbon film	3.9k		RD%PS 392J
R12	Carbon film	3.9k		RD%PS 392J
R13	Carbon film	1k		RD%PS 102J
R14	Carbon film	1k		RD%PS 102J
R15	Carbon film	220		RD%PS 221J
R16	Carbon film	220		RD%PS 221J
R17	Carbon film	3.2k		RD%PS 332J
R18	Carbon film	3.2k		RD%PS 332J
R19	Carbon film	1k		RD%PS 102J
R20	Carbon film	1k		RD%PS 102J

Symbol	Description	Part No.
R21	Carbon film 1k	RD%PS 102J
R22	Carbon film 47k	RD%PS 473J
R23	Metal film 1.54k ½W	RN%SR 1541F
R24	Metal film 1.54k ½W	RN%SR 1541F
R25	Metal film 75k ½W	RN%SR 7502F
R26	Metal film 75k ½W	RN%SR 7502F
R27	Metal film 953k ½W	RN%SR 9533F
R28	Metal film 953k ½W	RN%SR 9533F
R29	Carbon film 1k	RD%PS 102J
R30	Carbon film 1k	RD%PS 102J
R31	Carbon film 220	RD%PS 221J
R32	Carbon film 220	RD%PS 221J
R33	Carbon film 220	RD%PS 221J
R34	Carbon film 220	RD%PS 221J
R35	Carbon film 56	RD%PS 560J
R36	Carbon film 56	RD%PS 560J
R37	Carbon film 1k	RD%PS 102J
R38	Carbon film 1k	RD%PS 102J
R39	Carbon film 100k	RD%PS 104J
R40	Carbon film 100k	RD%PS 104J
R41	Carbon film 2.2k	RD%PS 222J
R42	Carbon film 2.2k	RD%PS 222J
R43	Carbon film 2.2k	RD%PS 222J
R44	Carbon film 2.2k	RD%PS 222J
R45	Carbon film 1k	RD%PS 102J

#### SEMICONDUCTORS

Symbol	Description	Part No.
Q1	FET 2SK34-D or C	
Q2	FET 2SK34-D or C	
Q3	FET 2SK34-D or C	
Q4	FET 2SK34-D or C	
Q5	Transistor 2SA628AP-D or C (2SA763UL-4)	
Q6	Transistor 2SA628AP-D or C (2SA763UL-4)	
Q7	Transistor 2SC869P-D or C	
Q8	Transistor 2SC869P-D or C	
Q9	Transistor 2SC145I-V, B or S	
Q10	Transistor 2SC145I-V, B or S	
Q11	Transistor 2SA809-V, B or	
Q12	Transistor 2SA809-V, B or	
D1	Diode 1S2473	

#### SWITCH

Symbol	Description	Part No.
S1	Rotary switch (FUNCTION)	ASD-021-A
S2	Lever switch (TAPE DUPLICATE)	ASK-084-A
S3	Lever switch (TAPE MONITOR)	ASK-086-A

## OTHERS

Symbol	Description	Part No.	
	Phono jack (4-jacks) Phono jack (6-jacks)	AKB-023-0 AKB-024-0	







## Parts List of Control Amplifier Assembly (AWG-031-0)

### CAPACITORS

Symbol	Description			Part No.
C1	Electrolytic	1	35V	CSZA 010M 35
C2	Electrolytic	1	35V	CSZA 010M 35
C3	Ceramic	47p	50V	CCDSL 470K 50
C4	Ceramic	47p	50V	CCDSL 470K 50
C5	Electrolytic	220	6V	CEA 221P 6
C6	Electrolytic	220	6V	CEA 221P 6
C7	Ceramic	3p	50V	CCDSL 030C 50
C8	Ceramic	3p	50V	CCDSL 030C 50
C9	Electrolytic	4.7	25V	CEANL 4R7P 25
C10	Electrolytic	4.7	25V	CEANL 4R7P 25
C11	Electrolytic	1	35V	CSZA 010M 35
C12	Electrolytic	1	35V	CSZA 010M 35
C13	Ceramic	10p	50V	CCDSL 100F 50
C14	Ceramic	10p	50V	CCDSL 100F 50
C15	Electrolytic	10	25V	CEANL 100P 25
C16	Electrolytic	10	25V	CEANL 100P 25

### RESISTORS

Symbol	Description			Part No.
R1	Carbon film	2.2k		RD%PS 222J
R2	Carbon film	2.2k		RD%PS 222J
R3	Carbon film	620k		RD%PS 624J
R4	Carbon film	620k		RD%PS 624J
R5	Carbon film	120k		RD%PS 124J
R6	Carbon film	120k		RD%PS 124J
R7	Carbon film	30k		RD%PS 303J
R8	Carbon film	30k		RD%PS 303J
R9	Carbon film	20k		RD%PS 203J
R10	Carbon film	20k		RD%PS 203J
R11	Carbon film	6.2k		RD%PS 622J
R12	Carbon film	6.2k		RD%PS 622J
R13	Carbon film	1k		RD%PS 102J
R14	Carbon film	1k		RD%PS 102J
R15	Carbon film	220		RD%PS 221J
R16	Carbon film	220		RD%PS 221J
R17	Carbon film	1M		RD%PS 105J
R18	Carbon film	1M		RD%PS 105J
R19	Carbon film	5.1k		RD%PS 512J
R20	Carbon film	5.1k		RD%PS 512J
R21	Carbon film	68k		RD%PS 683J
R22	Carbon film	68k		RD%PS 683J
R23	Carbon film	270k		RD%PS 274J
R24	Carbon film	270k		RD%PS 274J
R25	Carbon film	1k		RD%PS 102J

Symbol	Description	Part No.
R26	Carbon film 100k	RD%PS 104J
R27	Carbon film 1k	RD%PS 102J
R28	Carbon film 1k	RD%PS 102J
R29	Metal oxide film 5.6k 1W	RS1P 562J
R30	Metal oxide film 5.6k 1W	RS1P 562J
R31	Carbon film 220k	RD%PS 224J
R32	Carbon film 220k	RD%PS 224J
R33	Carbon film 51k	RD%PS 513J
R34	Carbon film 51k	RD%PS 513J
R35	Carbon film 33k	RD%PS 333J
R36	Carbon film 33k	RD%PS 333J
R37	Carbon film 33k	RD%PS 333J
R38	Carbon film 33k	RD%PS 333J
R39	Carbon film 18k	RD%PS 183J
R40	Carbon film 18k	RD%PS 183J
R41	Carbon film 560k	RD%PS 564J
R42	Carbon film 560k	RD%PS 564J
R43	Carbon film 1k	RD%PS 102J
R44	Carbon film 1k	RD%PS 102J
R45	Carbon film 12k ½W	RD%PS 123J
R46	Carbon film 12k ½W	RD%PS 123J
R47	Carbon film 1k	RD%PS 102J
R48	Carbon film 1k	RD%PS 102J
R49	Carbon film 220k	RD%PS 224J
R50	Carbon film 220k	RD%PS 224J

## SEMICONDUCTORS

Symbol	Description	Part No.
Q1	FET 2SK34-D or C	
Q2	FET 2SK34-D or C	
Q3	FET 2SK34-D or C	
Q4	FET 2SK34-D or C	
Q5	Transistor 2SA628AP-D or C	
Q6	Transistor 2SA628AP-D or C	
Q7	Transistor 2SC869P-D or C	
Q8	Transistor 2SC869P-D or C	
Q9	Transistor 2SC1451-B, V or S	
Q10	Transistor 2SC1451-B, V or S	
Q11	Transistor 2SC1451P-V or S	
Q12	Transistor 2SC1451P-V or S	
D1	Diode 1S2473	



## Foil Side

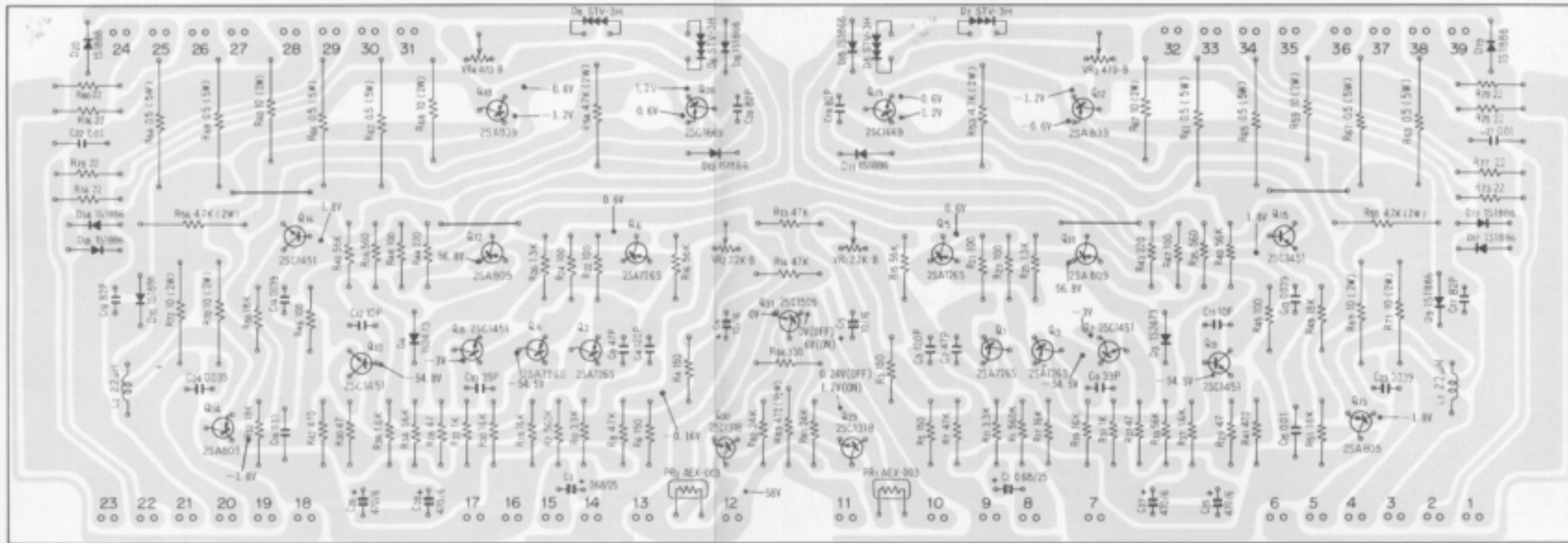

# Parts List of Power Amplifier Assembly (AWH-037-A)

## CAPACITORS

Symbol	Description			Part No.
C1	Electrolytic	0.68	25V	CSSA R68M 25
C2	Electrolytic	0.68	25V	CSSA R68M 25
C3	Ceramic	120p	50V	CCDSL 121K 50
C4	Ceramic	120p	50V	CCDSL 121K 50
C5	Electrolytic	10	16V	CEA 100P 16
C6	Electrolytic	10	16V	CEA 100P 16
C7	Ceramic	47p	50V	CCDSL 470K 50
C8	Ceramic	47p	50V	CCDSL 470K 50
C9	Ceramic	39p	50V	CCDSL 390K 50
C10	Ceramic	39p	50V	CCDSL 390K 50
C11	Ceramic	10p	500V	CCDSL 100K 500
C12	Ceramic	10p	500V	CCDSL 100K 500
C13	Mylar	0.039	50V	CQMA 393J 50
C14	Mylar	0.039	50V	CQMA 393J 50
C15	Ceramic	0.047	150V	ACG-009-0
C16	Ceramic	0.047	150V	ACG-009-0
C17	Ceramic	82p	500V	CCDSL 820K 500
C18	Ceramic	82p	500V	CCDSL 820K 500
C19	Ceramic	82p	500V	CCDSL 820K 500
C20	Ceramic	82p	500V	CCDSL 820K 500
C21	Ceramic	0.047	150V	ACG-009-0
C22	Ceramic	0.047	150V	ACG-009-0
C23	Mylar	0.039	50V	CQMA 393J 50
C24	Mylar	0.039	50V	CQMA 393J 50
C25	Electrolytic	470	6V	CEA 471P 6
C26	Electrolytic	470	6V	CEA 471P 6
C27	Electrolytic	470	6V	CEA 471P 6
C28	Electrolytic	470	6V	CEA 471P 6

## RESISTORS

Symbol	Description			Part No.
R1	Carbon film	560k		RD%PS 564J
R2	Carbon film	560k		RD%PS 564J
R3	Carbon film	150		RD%PS 151J
R4	Carbon film	150		RD%PS 151J
R5	Carbon film	150		RD%PS 151J
R6	Carbon film	150		RD%PS 151J
R7	Carbon film	47k		RD%PS 473J
R8	Carbon film	47k		RD%PS 473J
R9				
R10				
R11	Carbon film	3.3k		RD%PS 332J
R12	Carbon film	3.3k		RD%PS 332J
R13	Carbon film	47k		RD%PS 473J
R14	Carbon film	47k		RD%PS 473J
R15	Carbon film	56k		RD%PS 563J

Symbol	Description	Part No.
R16	Carbon film 56k	RD%PS 563J
R17	Carbon film 16k	RD%PS 163J
R18	Carbon film 16k	RD%PS 163J
R19	Carbon film 16k	RD%PS 163J
R20	Carbon film 16k	RD%PS 163J
R21	Carbon film 100	RD%PS 101J
R22	Carbon film 100	RD%PS 101J
R23	Carbon film 100	RD%PS 101J
R24	Carbon film 100	RD%PS 101J
R25	Carbon film 1.3k	RD%PS 132J
R26	Carbon film 1.3k	RD%PS 132J
R27	Carbon film 47	RD%PS 470J
R28	Carbon film 47	RD%PS 470J
R29	Carbon film 47	RD%PS 470J
R30	Carbon film 47	RD%PS 470J
R31	Carbon film 1k	RD%PS 102J
R32	Carbon film 1k	RD%PS 102J
R33	Carbon film 56k	RD%PS 563J
R34	Carbon film 56k	RD%PS 563J
R35	Carbon film 560	RD%PS 561J
R36	Carbon film 560	RD%PS 561J
R37	Carbon film 1.6k	RD%PS 162J
R38	Carbon film 1.6k	RD%PS 162J
R39	Carbon film 56k	RD%PS 563J
R40	Carbon film 56k	RD%PS 563J
R41	Carbon film 470	RD%PS 471J
R42	Carbon film 470	RD%PS 471J
R43	Carbon film 220	RD%PS 221J
R44	Carbon film 220	RD%PS 221J
R45	Carbon film 100	RD%PS 101J
R46	Carbon film 100	RD%PS 101J
R47	Carbon film 100	RD%PS 101J
R48	Carbon film 100	RD%PS 101J
R49	Carbon film 18k	RD%PS 183J
R50	Carbon film 18k	RD%PS 183J
R51	Carbon film 18k	RD%PS 183J
R52	Carbon film 18k	RD%PS 183J
R53	Metal oxide film 4.7k 2W	RS2P 472J
R54	Metal oxide film 4.7k 2W	RS2P 472J
R55	Metal oxide film 4.7k 2W	RS2P 472J
R56	Metal oxide film 4.7k 2W	RS2P 472J
R57	Metal oxide film 10 2W	RS2P 100J
R58	Metal oxide film 10 2W	RS2P 100J
R59	Metal oxide film 10 2W	RS2P 100J
R60	Metal oxide film 10 2W	RS2P 100J
R61	Wire wound 0.5 5W	RT5B 0R5K
R62	Wire wound 0.5 5W	RT5B 0R5K
R63	Wire wound 0.5 5W	RT5B 0R5K
R64	Wire wound 0.5 5W	RT5B 0R5K
R65	Wire wound 0.5 5W	RT5B 0R5K

Symbol	Description	Part No.
R66	Wire wound 0.5 5W	RT5B 0R5K
R67	Wire wound 0.5 5W	RT5B 0R5K
R68	Wire wound 0.5 5W	RT5B 0R5K
R69	Metal oxide film 10 2W	RS2P 100J
R70	Metal oxide film 10 2W	RS2P 100J
R71	Metal oxide film 10 2W	RS2P 100J
R72	Metal oxide film 10 2W	RS2P 100J
R73	Carbon film 22	RD%PS 220J
R74	Carbon film 22	RD%PS 220J
R75	Carbon film 22	RD%PS 220J
R76	Carbon film 22	RD%PS 220J
R77	Carbon film 22	RD%PS 220J
R78	Carbon film 22	RD%PS 220J
R79	Carbon film 22	RD%PS 220J
R80	Carbon film 22	RD%PS 220J
R81	Carbon film 24k	RD%PS 243J
R82	Carbon film 24k	RD%PS 243J
R83	Carbon film 470 1/2W	RD%PS 471J
R84	Carbon film 330	RD%PS 331J
VR1	Semi-fixed 2.2k-B	ACP-041-A
VR2	Semi-fixed 2.2k-B	ACP-041-A
VR3	Semi-fixed 470-B	ACP-040-A
VR4	Semi-fixed 470-B	ACP-040-A

## SEMICONDUCTORS

Symbol	Description	Part No.
Q1	Transistor 2SA726S-G or F (2SA763S-6 or 5)	
Q2	Transistor 2SA726S-G or F (2SA763S-6 or 5)	
Q3	Transistor 2SA726S-G or F (2SA763S-6 or 5)	
Q4	Transistor 2SA726S-G or F (2SA763S-6 or 5)	
Q5	Transistor 2SA726S-G or F (2SA763S-6 or 5)	
Q6	Transistor 2SA726S-G or F (2SA763S-6 or 5)	
Q7	Transistor 2SC1451-V or B	
Q8	Transistor 2SC1451-V or B	
Q9	Transistor 2SC1451-V or B	
Q10	Transistor 2SC1451-V or B	
Q11	Transistor 2SA809-V, B or G	
Q12	Transistor 2SA809-V, B or G	
Q13	Transistor 2SA809-V, B or G	
Q14	Transistor 2SA809-V, B or G	
Q15	Transistor 2SC1451-V, B or G	

Continued on the Next Page

Symbol	Description	Part No.
Q16	Transistor 2SC1451-V, B or G	AEX-003-0 AEX-003-0
Q17	Transistor 2SA839-Y, O or R	
Q18	Transistor 2SA839-Y, O or R	
Q19	Transistor 2SC1669-Y, O or R	
Q20	Transistor 2SC1669-Y, O or R	
Q29	Transistor 2SC1318-R or Q	
Q30	Transistor 2SC1318-R or Q	
Q31	Transistor 2SC1509-R or Q	
PR1	Posistor	
PR2	Posistor	
D3	Diode 1S2473	
D4	Diode 1S2473	
D5	Varistor STV-3H	
D6	Varistor STV-3H	
D7	Varistor STV-3H	
D8	Varistor STV-3H	
D9	Diode 1S 1886 (S1B01-02)	
D10	Diode 1S 1886 (S1B01-02)	
D11	Diode 1S 1886 (S1B01-02)	
D12	Diode 1S 1886 (S1B01-02)	
D13	Diode 1S 1886 (S1B01-02)	
D14	Diode 1S 1886 (S1B01-02)	
D15	Diode 1S 1886 (S1B01-02)	
D16	Diode 1S 1886 (S1B01-02)	
D17	Diode 1S 1886 (S1B01-02)	
D18	Diode 1S 1886 (S1B01-02)	
D19	Diode 1S 1886 (S1B01-02)	
D20	Diode 1S 1886 (S1B01-02)	

#### OTHERS

Symbol	Description	Part No.
	Heat sink	ANH-237-0
	Transistor socket	AKH-002-0
	Insulator wafer	AEC-078-0
	Spacer	ANG-108-0
L1	Choke coil 2.2 $\mu$ H	T63-009-0
L2	Choke coil 2.2 $\mu$ H	T63-009-0



## 10.6 PROTECTION CIRCUIT ASSEMBLY (AWM-071-0)

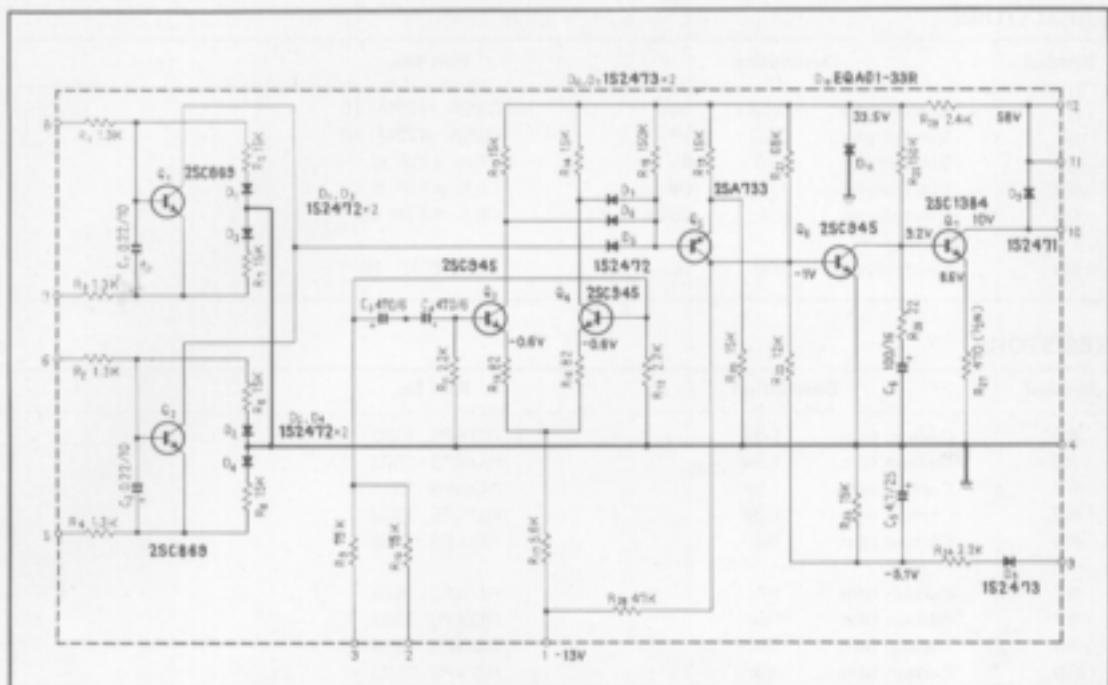

Foil Side

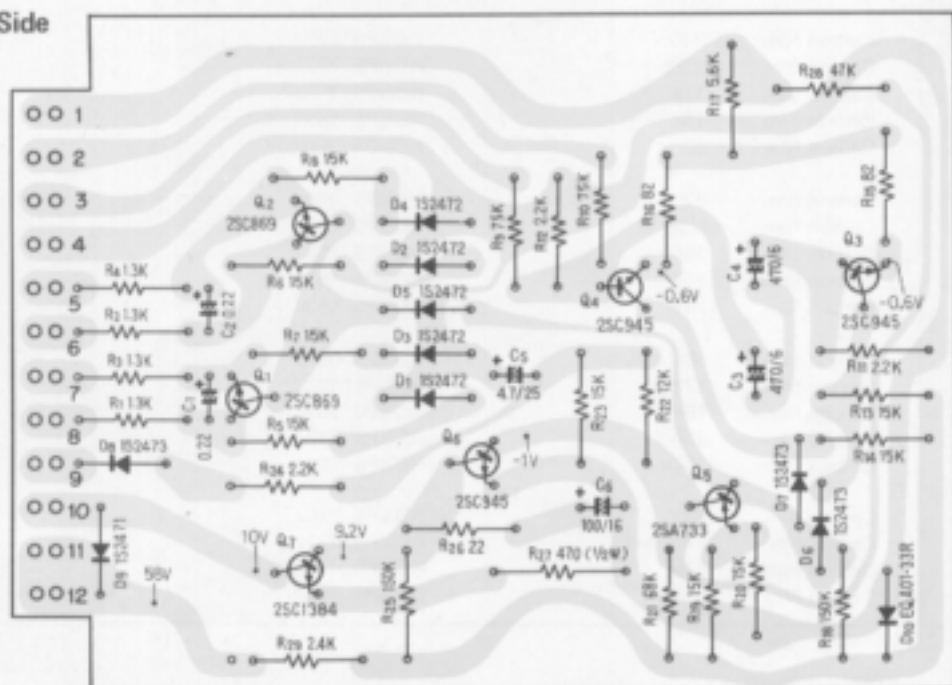

2SC869

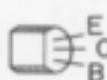
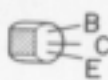
2SC945  
2SA733

25C1384



022-AB  
**Parts List of Protection Circuit Assembly (AWM-071-0)**

**CAPACITORS**

Symbol	Description	Part No.
C1	Electrolytic 0.22 10V	CSSA R22M 10
C2	Electrolytic 0.22 10V	CSSA R22M 10
C3	Electrolytic 470 6V	CEA 471P 6
C4	Electrolytic 470 6V	CEA 471P 6
C5	Electrolytic 4.7 25V	CEA 4R7P 25
C6	Electrolytic 100 16V	CEA 101P 16

**RESISTORS**

Symbol	Description	Part No.
R1	Carbon film 1.3k	RD%PS 132J
R2	Carbon film 1.3k	RD%PS 132J
R3	Carbon film 1.3k	RD%PS 132J
R4	Carbon film 1.3k	RD%PS 132J
R5	Carbon film 15k	RD%PS 153J
R6	Carbon film 15k	RD%PS 153J
R7	Carbon film 15k	RD%PS 153J
R8	Carbon film 15k	RD%PS 153J
R9	Carbon film 75k	RD%PS 753J
R10	Carbon film 75k	RD%PS 753J
R11	Carbon film 2.2k	RD%PS 222J
R12	Carbon film 2.2k	RD%PS 222J
R13	Carbon film 15k	RD%PS 153J
R14	Carbon film 15k	RD%PS 153J
R15	Carbon film 82	RD%PS 820J
R16	Carbon film 82	RD%PS 820J
R17	Carbon film 5.6k	RD%PS 562J
R18	Carbon film 150k	RD%PS 154J
R19	Carbon film 15k	RD%PS 153J
R20	Carbon film 15k	RD%PS 153J
R21	Carbon film 68k	RD%PS 683J
R22	Carbon film 12k	RD%PS 123J
R23	Carbon film 15k	RD%PS 153J
R24	Carbon film 2.2k	RD%PS 222J
R25	Carbon film 150k	RD%PS 154J
R26	Carbon film 22	RD%PS 220J
R27	Carbon film 470 $\frac{1}{2}W$	RD%PS 471J
R28	Carbon film 47k	RD%PS 473J
R29	Carbon film 2.4k	RD%PS 242J

## SEMICONDUCTORS

Symbol	Description	Part No.
Q1	Transistor 2SC869-C or D	
Q2	Transistor 2SC869-C or D	
Q3	Transistor 2SC945-Q or R	
Q4	Transistor 2SC945-Q or R	
Q5	Transistor 2SA733-Q or R	
Q6	Transistor 2SC945-Q or R	
Q7	Transistor 2SC1384-R or Q	
D1	Diode 1S2472 (1S1554)	
D2	Diode 1S2472 (1S1554)	
D3	Diode 1S2472 (1S1554)	
D4	Diode 1S2472 (1S1554)	
D5	Diode 1S2472 (1S1554)	
D6	Diode 1S2473 (1S1555)	
D7	Diode 1S2473 (1S1555)	
D8	Diode 1S2473 (1S1555)	
D9	Diode 1S2471	
D10	Zener diode EQA01-33R	

## 10.7 FUSE BOARD ASSEMBLY (AWX-083-0)

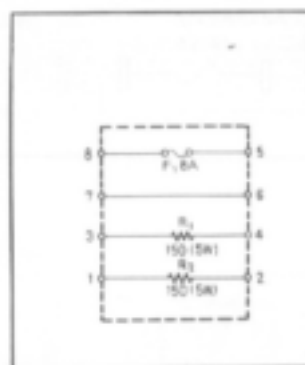

## Foil Side

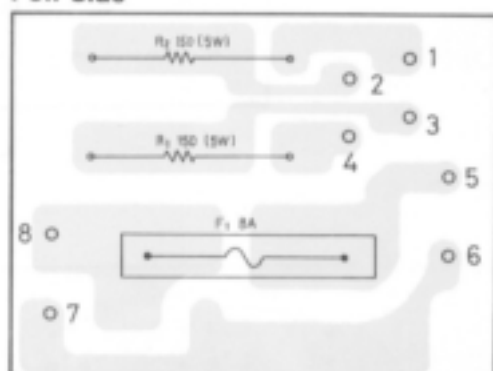

## Parts List of Fuse Board Assembly (AWX-083-0)

Symbol	Description	Part No.
	Fuse clip	AKR-013-0
R1	Wire wound resistor 150 5W	RT5B 151K
R2	Wire wound resistor 150 5W	RT5B 151K

## 10.8 POWER SUPPLY CIRCUIT ASSEMBLY-1 (AWR-069-A)

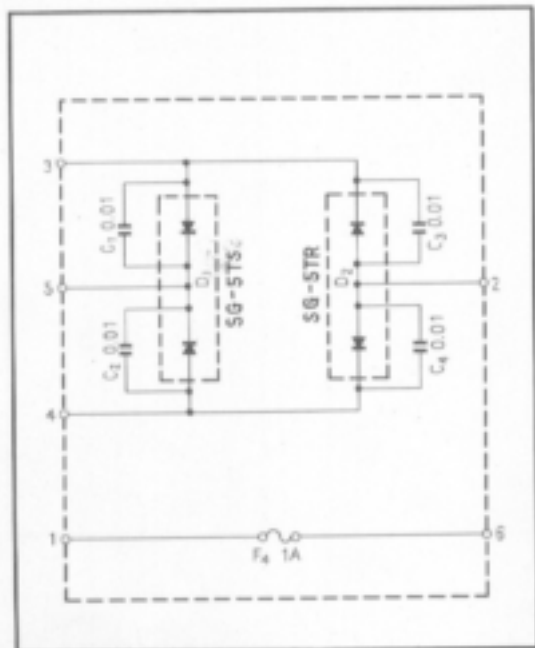

Foil Side

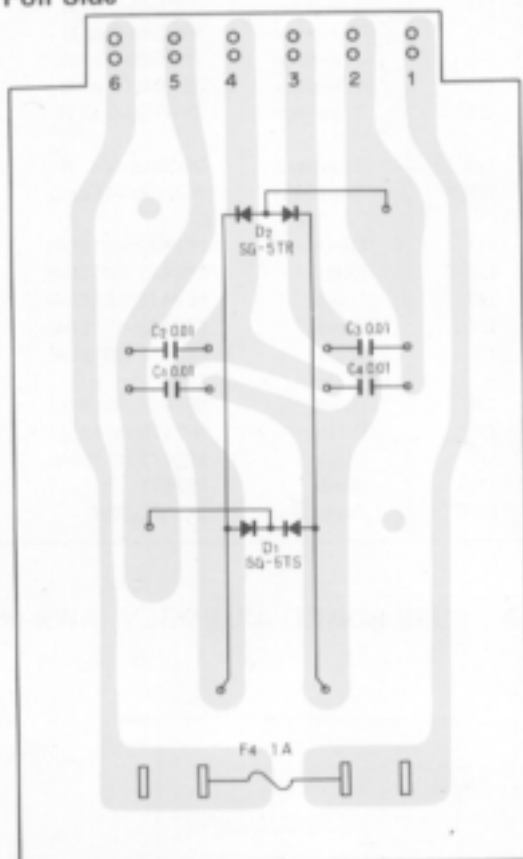

### Parts List of Power Supply Circuit Assembly-1 (AWR-069-A)

Symbol	Description	Part No.	
C1	Ceramic capacitor 0.01 150V	ACG-004-0	
C2	Ceramic capacitor 0.01 150V	ACG-004-0	
C3	Ceramic capacitor 0.01 150V	ACG-004-0	
C4	Ceramic capacitor 0.01 150V	ACG-004-0	
D1	Diode SG-5TS		
D2	Diode SG-5TR		
	Heat sink	ANH-187-B	
	Jumper	ADX-006-A	
	Insulator water	AEC-076-0	
	Insulator bush	E32-047-0	
	Fuse clip	AKR-013-0	

## 10.9 POWER SUPPLY CIRCUIT ASSEMBLY-2 (AWR-070-A)

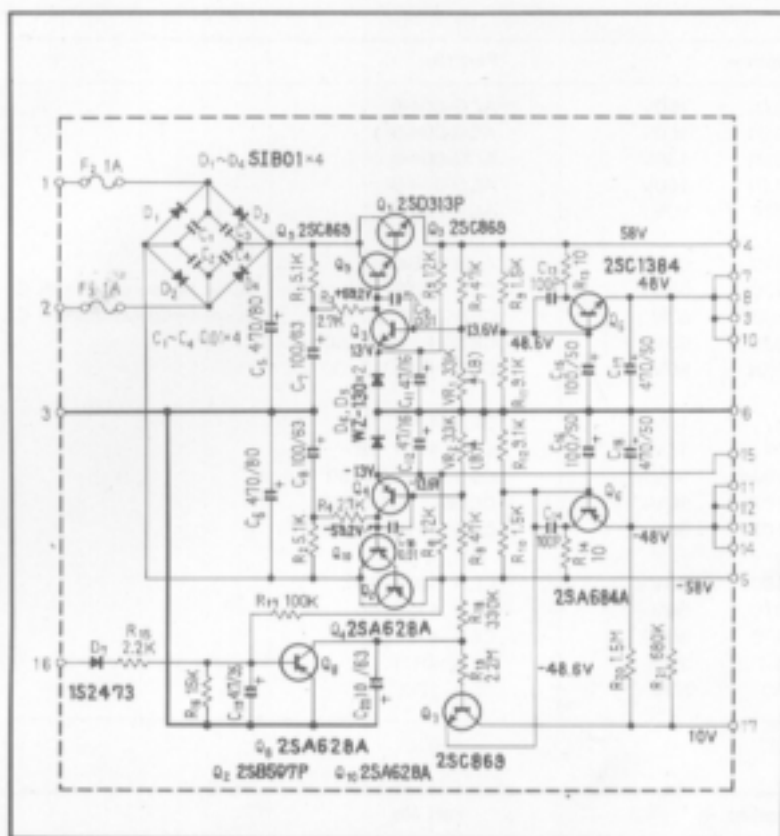

2SD313P  
2SB507P

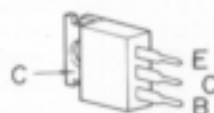

2SC869  
2SA628A

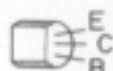

2SC1649  
2SA834



2SC1384  
2SA684A



## Foil Side

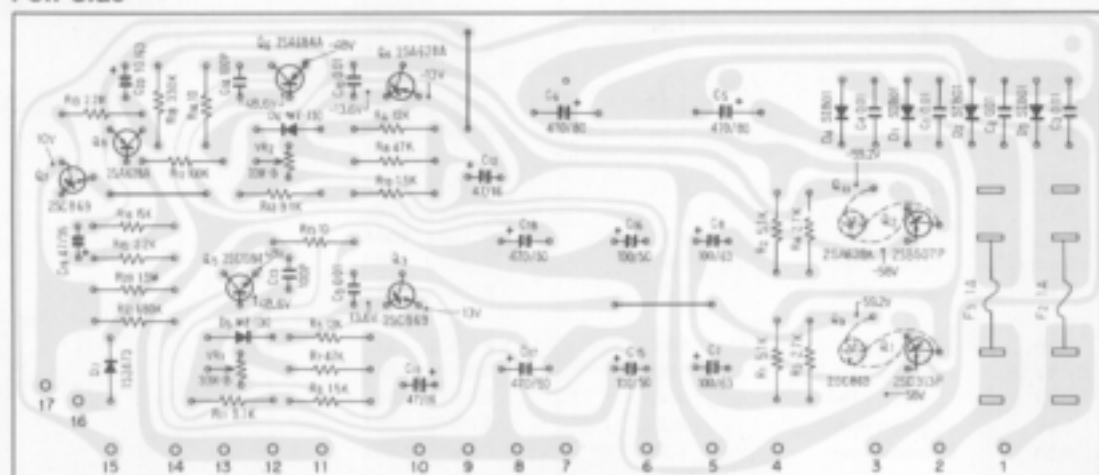

## Parts List of Power Supply Circuit Assembly-2 (AWR-070-A)

## CAPACITORS

Symbol	Description			Part No.	
C1	Ceramic	0.01	150V	ACG-004-0	
C2	Ceramic	0.01	150V	ACG-004-0	
C3	Ceramic	0.01	150V	ACG-004-0	
C4	Ceramic	0.01	150V	ACG-004-0	
C5	Electrolytic	470	80V	ACH-038-0	
C6	Electrolytic	470	80V	ACH-038-0	
C7	Electrolytic	100	63V	CEA 101P 63	Surge temperatures+85°C Surge temperatures+85°C
C8	Electrolytic	100	63V	CEA 101P 63	
C9	Ceramic	0.01	50V	CKDYF 103Z 50	
C10	Ceramic	0.01	50V	CKDYF 103Z 50	
C11	Electrolytic	47	16V	CEA 470P 16	
C12	Electrolytic	47	16V	CEA 470P 16	
C13	Ceramic	100p	50V	CCDSL 101K 50	
C14	Ceramic	100p	50V	CCDSL 101K 50	
C15	Electrolytic	100	50V	CEA 101P 50	
C16	Electrolytic	100	50V	CEA 101P 50	
C17	Electrolytic	470	50V	CEA 471P 50	
C18	Electrolytic	470	50V	CEA 471P 50	
C19	Electrolytic	4.7	35V	CEA 4R7P 35	
C20	Electrolytic	10	63V	CEA 100P 63	

## RESISTORS

Symbol	Description		Part No.	
R1	Carbon film	5.1k	RD%PS 512J	
R2	Carbon film	5.1k	RD%PS 512J	
R3	Carbon film	2.7k	RD%PS 272J	
R4	Carbon film	2.7k	RD%PS 272J	
R5	Carbon film	12k	RD%PS 123J	
R6	Carbon film	12k	RD%PS 123J	
R7	Carbon film	47k	RD%PS 473J	
R8	Carbon film	47k	RD%PS 473J	
R9	Carbon film	1.5k	RD%PS 152J	
R10	Carbon film	1.5k	RD%PS 152J	
R11	Carbon film	9.1k	RD%PS 912J	
R12	Carbon film	9.1k	RD%PS 912J	
R13	Carbon film	10	RD%PS 100J	
R14	Carbon film	10	RD%PS 100J	
R15	Carbon film	2.2k	RD%PS 222J	
R16	Carbon film	15k	RD%PS 153J	
R17	Carbon film	100k	RD%PS 104J	
R18	Carbon film	330k	RD%PS 334J	
R19	Carbon film	2.2M	RD%PS 225J	
R20	Carbon film	1.5M	RD%PS 155J	
R21	Carbon film	680k	RD%PS 684J	

Symbol	Description	Part No.
VR1	Semi-fixed 33k-B	ACP-044-0
VR2	Semi-fixed 33k-B	ACP-044-0

## SEMICONDUCTORS

Symbol	Description	Part No.
Q1	Transistor 2SD313P-D or E	
Q2	Transistor 2SB507P-D or E	
Q3	Transistor 2SC869-C or D (2SC1649-N or P)	
Q4	Transistor 2SA628A-C or D (2SA834-N or P)	
Q5	Transistor 2SC1384-Q or R	
Q6	Transistor 2SA684A-Q or R	
Q7	Transistor 2SC869-C or D (2SC1649-N or P)	
Q8	Transistor 2SA628A-C or D (2SA834-N or P)	
Q9	Transistor 2SC869-C or D (2SC1649-N or P)	
Q10	Transistor 2SA628A-C or D (2SA834-N or P)	
D1	Diode 1S1801-02 (1S1886)	
D2	Diode 1S1801-02 (1S1886)	
D3	Diode 1S1801-02 (1S1886)	
D4	Diode 1S1801-02 (1S1886)	
D5	Zener diode WZ-130	
D6	Zener diode 1S2473 (1S1555)	

## OTHERS

Symbol	Description	Part No.
	Fuse clip	AKR-013-0
	Heat sink	ANH-259-0

## 10.10 POWER SUPPLY CIRCUIT ASSEMBLY (AWR-077-0)

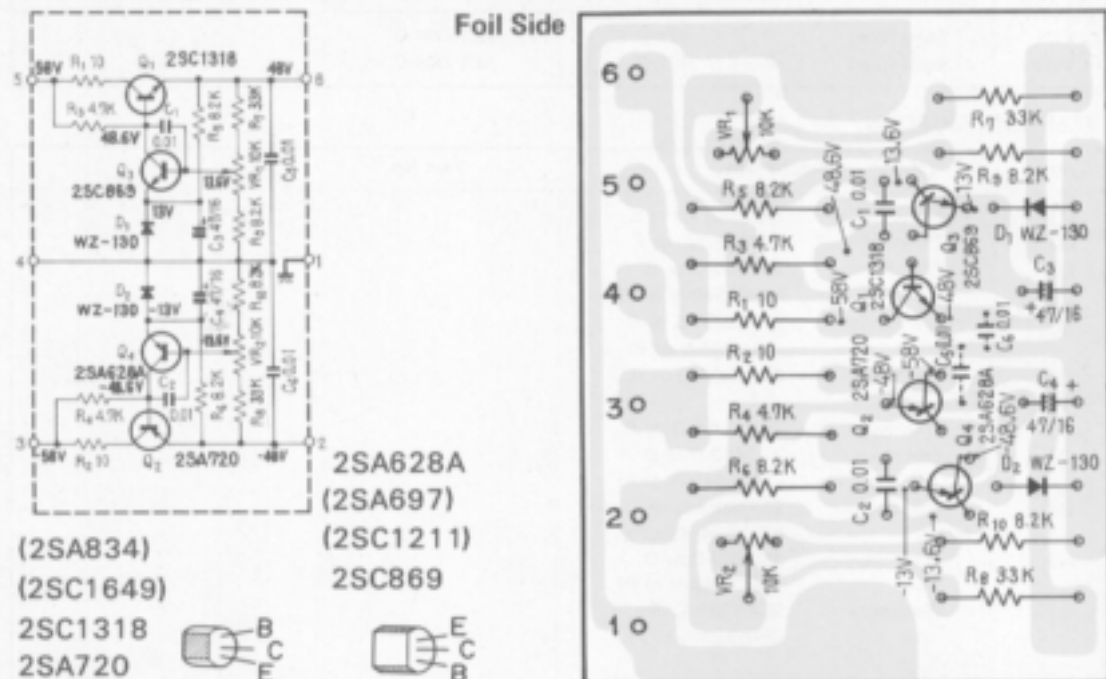

### Parts List of Power Supply Circuit Assembly-3 (AWR-077-0)

#### CAPACITORS

Symbol	Description	Part No.
C1	Ceramic 0.01 50V	CKDYF 103Z 50
C2	Ceramic 0.01 50V	CKDYF 103Z 50
C3	Electrolytic 47 16V	CEA 470P 16
C4	Electrolytic 47 16V	CEA 470P 16
C5	Ceramic 0.01 50V	CKDYF 103Z 50
C6	Ceramic 0.01 50V	CKDYF 103Z 50

#### RESISTORS

Symbol	Description	Part No.
VR1	Semi-fixed 10k-B	ACP-036-0
VR2	Semi-fixed 10k-B	ACP-036-0
R1	Carbon film 10	RD%PS 100J
R2	Carbon film 10	RD%PS 100J
R3	Carbon film 4.7k	RD%PS 472J
R4	Carbon film 4.7k	RD%PS 472J
R5	Carbon film 8.2k	RD%PS 822J
R6	Carbon film 8.2k	RD%PS 822J
R7	Carbon film 33k	RD%PS 333J
R8	Carbon film 33k	RD%PS 333J
R9	Carbon film 8.2k	RD%PS 822J
R10	Carbon film 8.2k	RD%PS 822J





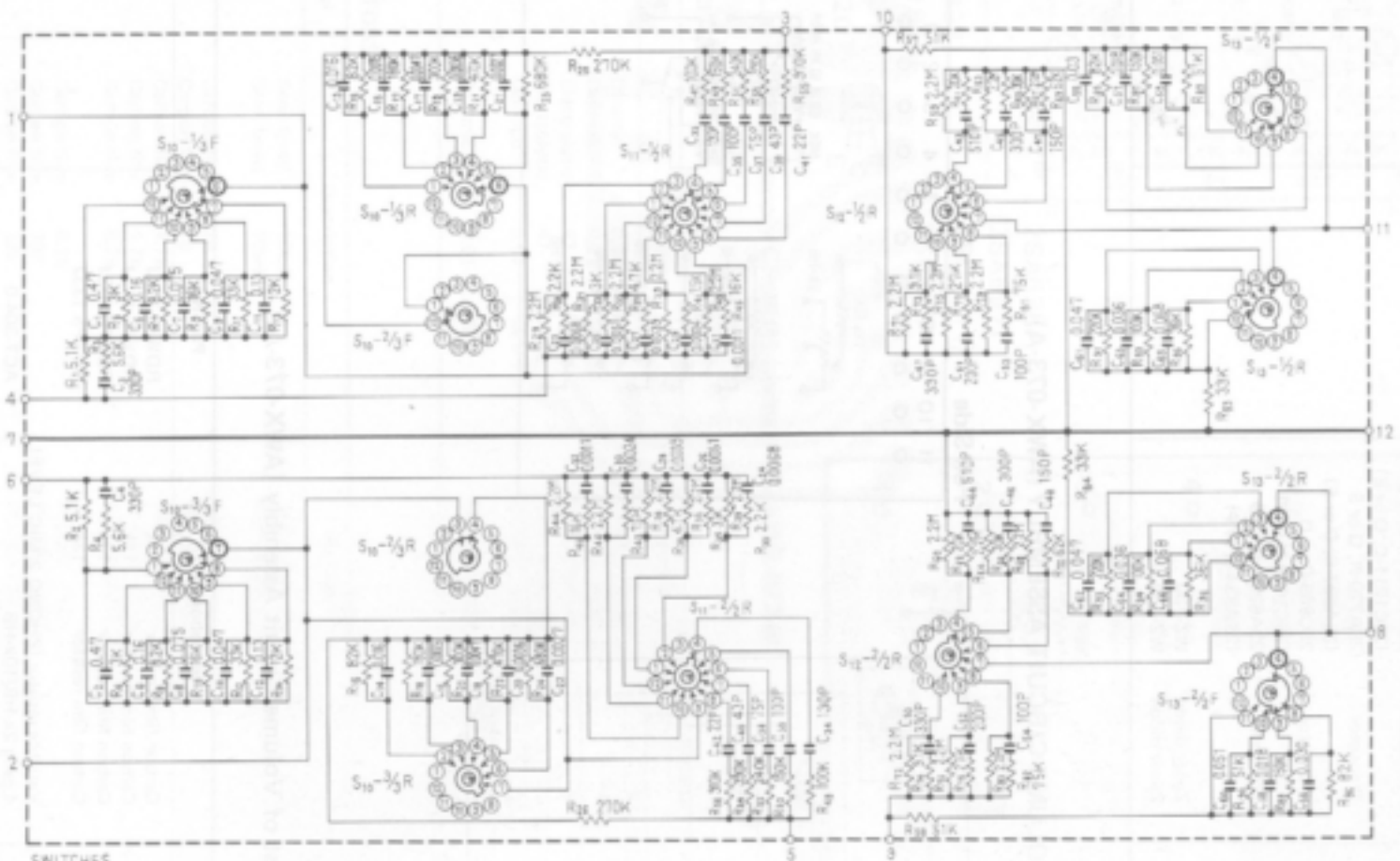

## SWITCHES

\$S\_{10}\$ - BASS CONTROL (100kHz)  
-7.5dB ~ +7.5dB, 1.5dB STEP

\$S\_{11}\$ - TREBLE CONTROL (10kHz)  
-7.5dB ~ +7.5dB, 1.5dB STEP

\$S\_{12}\$ - TREBLE CONTROL (20kHz)  
-4.5dB ~ +4.5dB, 1.5dB STEP

\$S\_{13}\$ - BASS CONTROL (50kHz)  
-4.5dB ~ +4.5dB, 1.5dB STEP

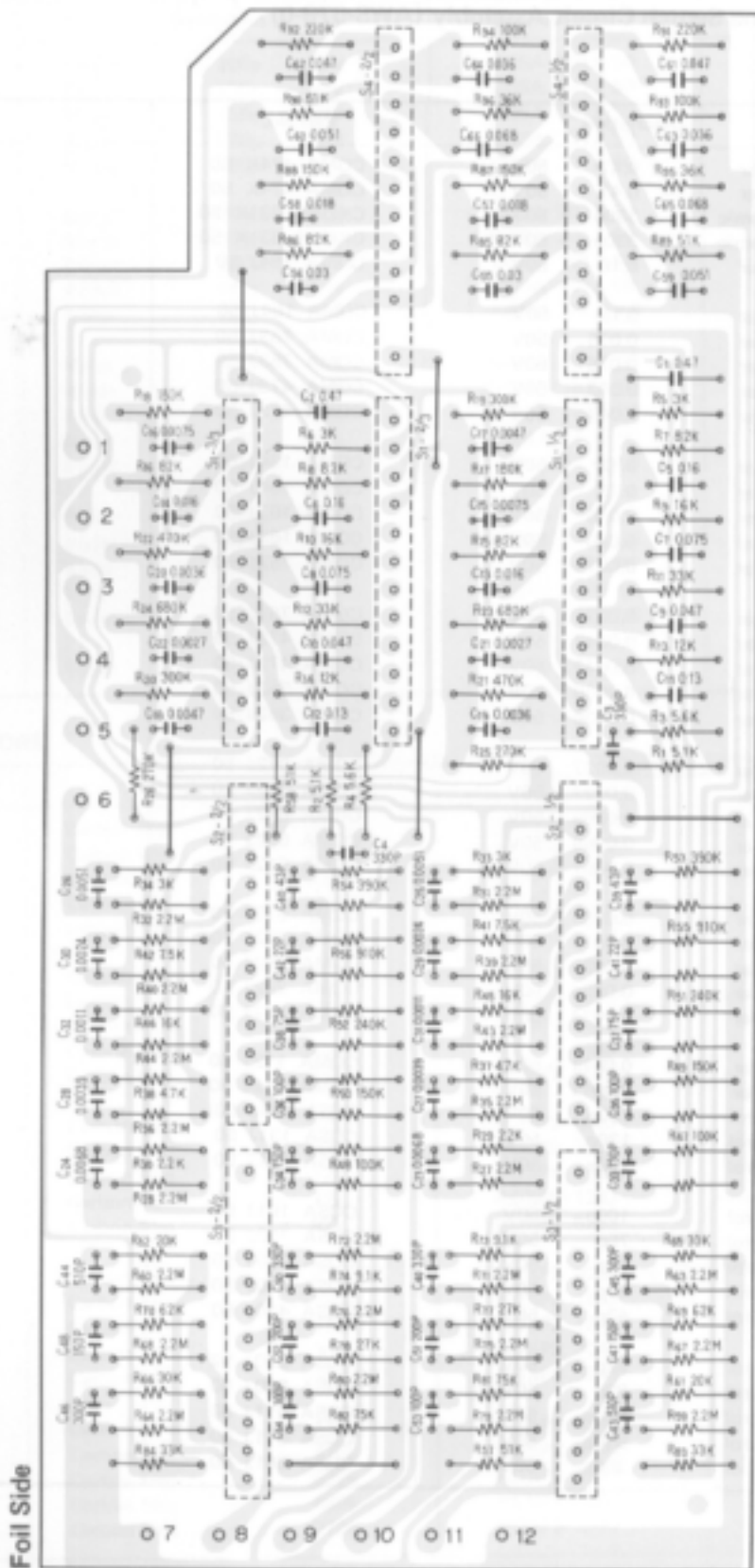

# Parts List of Tone Switch Circuit Assembly (AWS-079-0)

## CAPACITORS

Symbol	Description			Part No.
C1	Mylar	0.47	50V	CQMA 474K 50
C2	Mylar	0.47	50V	CQMA 474K 50
C3	Ceramic	330p	50V	CKDYB 331K 50
C4	Ceramic	330p	50V	CKDYB 331K 50
C5	Mylar	0.16	50V	CQMA 164J 50
C6	Mylar	0.16	50V	CQMA 164J 50
C7	Mylar	0.075	50V	CQMA 753J 50
C8	Mylar	0.075	50V	CQMA 753J 50
C9	Mylar	0.047	50V	CQMA 473J 50
C10	Mylar	0.047	50V	CQMA 473J 50
C11	Mylar	0.13	50V	CQMA 134J 50
C12	Mylar	0.13	50V	CQMA 134J 50
C13	Mylar	0.016	50V	CQMA 163J 50
C14	Mylar	0.016	50V	CQMA 163J 50
C15	Mylar	0.0075	50V	CQMA 752J 50
C16	Mylar	0.0075	50V	CQMA 752J 50
C17	Mylar	0.0047	50V	CQMA 472J 50
C18	Mylar	0.0047	50V	CQMA 472J 50
C19	Mylar	0.0036	50V	CQMA 362J 50
C20	Mylar	0.0036	50V	CQMA 362J 50
C21	Mylar	0.0027	50V	CQMA 272J 50
C22	Mylar	0.0027	50V	CQMA 272J 50
C23	Mylar	0.0068	50V	CQMA 682J 50
C24	Mylar	0.0068	50V	CQMA 682J 50
C25	Mylar	0.0051	50V	CQMA 512J 50
C26	Mylar	0.0051	50V	CQMA 512J 50
C27	Mylar	0.0039	50V	CQMA 392J 50
C28	Mylar	0.0039	50V	CQMA 392J 50
C29	Mylar	0.0024	50V	CQMA 242J 50
C30	Mylar	0.0024	50V	CQMA 242J 50
C31	Mylar	0.0011	50V	CQMA 112J 50
C32	Mylar	0.0011	50V	CQMA 112J 50
C33	Styrol	130p	50V	CQSA 131J 50
C34	Styrol	130p	50V	CQSA 131J 50
C35	Styrol	100p	50V	CQSA 101J 50
C36	Styrol	100p	50V	CQSA 101J 50
C37	Styrol	75p	50V	CQSA 750J 50
C38	Styrol	75p	50V	CQSA 750J 50
C39	Styrol	43p	50V	CQSA 430J 50
C40	Styrol	43p	50V	CQSA 430J 50
C41	Styrol	22p	50V	CQSA 220J 50
C42	Styrol	22p	50V	CQSA 220J 50
C43	Styrol	510p	50V	CQSA 511J 50
C44	Styrol	510p	50V	CQSA 511J 50
C45	Styrol	300p	50V	CQSA 301J 50

Symbol	Description			Part No.
C46	Styrol	300p	50V	CQSA 301J 50
C47	Styrol	150p	50V	CQSA 151J 50
C48	Styrol	150p	50V	CQSA 151J 50
C49	Styrol	330p	50V	CQSA 331J 50
C50	Styrol	330p	50V	CQSA 331J 50
C51	Styrol	200p	50V	CQSA 201J 50
C52	Styrol	200p	50V	CQSA 201J 50
C53	Styrol	100p	50V	CQSA 101J 50
C54	Styrol	100p	50V	CQSA 101J 50
C55	Mylar	0.03	50V	CQMA 303J 50
C56	Mylar	0.03	50V	CQMA 303J 50
C57	Mylar	0.018	50V	CQMA 183J 50
C58	Mylar	0.018	50V	CQMA 183J 50
C59	Mylar	0.051	50V	CQMA 513J 50
C60	Mylar	0.051	50V	CQMA 513J 50
C61	Mylar	0.047	50V	CQMA 473J 50
C62	Mylar	0.047	50V	CQMA 473J 50
C63	Mylar	0.036	50V	CQMA 363J 50
C64	Mylar	0.036	50V	CQMA 363J 50
C65	Mylar	0.068	50V	CQMA 683J 50
C66	Mylar	0.068	50V	CQMA 683J 50

## RESISTORS

Symbol	Description			Part No.
R1	Carbon film	5.1k		RD%PS 512J
R2	Carbon film	5.1k		RD%PS 512J
R3	Carbon film	5.6k		RD%PS 562J
R4	Carbon film	5.6k		RD%PS 562J
R5	Carbon film	3k		RD%PS 302J
R6	Carbon film	3k		RD%PS 302J
R7	Carbon film	8.2k		RD%PS 822J
R8	Carbon film	8.2k		RD%PS 822J
R9	Carbon film	16k		RD%PS 163J
R10	Carbon film	16k		RD%PS 163J
R11	Carbon film	33k		RD%PS 333J
R12	Carbon film	33k		RD%PS 333J
R13	Carbon film	12k		RD%PS 123J
R14	Carbon film	12k		RD%PS 123J
R15	Carbon film	82k		RD%PS 823J
R16	Carbon film	82k		RD%PS 823J
R17	Carbon film	180k		RD%PS 184J
R18	Carbon film	180k		RD%PS 184J
R19	Carbon film	300k		RD%PS 304J
R20	Carbon film	300k		RD%PS 304J
R21	Carbon film	470k		RD%PS 474J
R22	Carbon film	470k		RD%PS 474J
R23	Carbon film	680k		RD%PS 684J
R24	Carbon film	680k		RD%PS 684J
R25	Carbon film	270k		RD%PS 274J

Continued on the Next Page

Symbol	Description	Part No.
R26	Carbon film 270k	RD%PS 274J
R27	Carbon film 2.2M	RD%PS 225J
R28	Carbon film 2.2M	RD%PS 225J
R29	Carbon film 2.2k	RD%PS 222J
R30	Carbon film 2.2k	RD%PS 222J
R31	Carbon film 2.2M	RD%PS 225J
R32	Carbon film 2.2M	RD%PS 225J
R33	Carbon film 3k	RD%PS 302J
R34	Carbon film 3k	RD%PS 302J
R35	Carbon film 2.2M	RD%PS 225J
R36	Carbon film 2.2M	RD%PS 225J
R37	Carbon film 4.7k	RD%PS 472J
R38	Carbon film 4.7k	RD%PS 472J
R39	Carbon film 2.2M	RD%PS 225J
R40	Carbon film 2.2M	RD%PS 225J
R41	Carbon film 7.5k	RD%PS 752J
R42	Carbon film 7.5k	RD%PS 752J
R43	Carbon film 2.2M	RD%PS 225J
R44	Carbon film 2.2M	RD%PS 225J
R45	Carbon film 16k	RD%PS 163J
R46	Carbon film 16k	RD%PS 163J
R47	Carbon film 100k	RD%PS 104J
R48	Carbon film 100k	RD%PS 104J
R49	Carbon film 150k	RD%PS 154J
R50	Carbon film 150k	RD%PS 154J
R51	Carbon film 240k	RD%PS 244J
R52	Carbon film 240k	RD%PS 244J
R53	Carbon film 390k	RD%PS 394J
R54	Carbon film 390k	RD%PS 394J
R55	Carbon film 910k	RD%PS 914J
R56	Carbon film 910k	RD%PS 914J
R57	Carbon film 51k	RD%PS 513J
R58	Carbon film 51k	RD%PS 513J
R59	Carbon film 2.2M	RD%PS 225J
R60	Carbon film 2.2M	RD%PS 225J
R61	Carbon film 20k	RD%PS 203J
R62	Carbon film 20k	RD%PS 203J
R63	Carbon film 2.2M	RD%PS 225J
R64	Carbon film 2.2M	RD%PS 225J
R65	Carbon film 30k	RD%PS 303J
R66	Carbon film 30k	RD%PS 303J
R67	Carbon film 2.2M	RD%PS 225J
R68	Carbon film 2.2M	RD%PS 225J
R69	Carbon film 62k	RD%PS 623J
R70	Carbon film 62k	RD%PS 623J
R71	Carbon film 2.2M	RD%PS 225J
R72	Carbon film 2.2M	RD%PS 225J
R73	Carbon film 9.1k	RD%PS 912J
R74	Carbon film 9.1k	RD%PS 912J
R75	Carbon film 2.2M	RD%PS 225J

Symbol	Description	Part No.
R76	Carbon film 2.2M	RD%PS 225J
R77	Carbon film 27k	RD%PS 273J
R78	Carbon film 27k	RD%PS 273J
R79	Carbon film 2.2M	RD%PS 225J
R80	Carbon film 2.2M	RD%PS 225J
R81	Carbon film 75k	RD%PS 753J
R82	Carbon film 75k	RD%PS 753J
R83	Carbon film 33k	RD%PS 333J
R84	Carbon film 33k	RD%PS 333J
R85	Carbon film 82k	RD%PS 823J
R86	Carbon film 82k	RD%PS 823J
R87	Carbon film 150k	RD%PS 154J
R88	Carbon film 150k	RD%PS 154J
R89	Carbon film 51k	RD%PS 513J
R90	Carbon film 51k	RD%PS 513J
R91	Carbon film 220k	RD%PS 224J
R92	Carbon film 220k	RD%PS 224J
R93	Carbon film 100k	RD%PS 104J
R94	Carbon film 100k	RD%PS 104J
R95	Carbon film 36k	RD%PS 363J
R96	Carbon film 36k	RD%PS 363J

## SWITCHES

Symbol	Description	Part No.
S1	Rotary switch (BASS, 100Hz)	ASD-023-B
S2	Rotary switch (TREBLE, 10kHz )	ASD-024-A
S3	Rotary switch (TREBLE, 20kHz )	ASD-025-A
S4	Rotary switch (BASS, 50Hz)	ASD-022-A

## OTHERS

Symbol	Description	Part No.
	Boss	ABN-009-0
	Washer (9φ)	B22-016-0
	Nut (9φ)	B71-004-0
	Internal lock washer	ABE-001-0







# Parts List of Switch Circuit Assembly (AWS-080-0)

## CAPACITORS

Symbol	Description			Part No.
C1	Electrolytic	2.2	50V	CEANL 2R2P 50
C2	Electrolytic	2.2	50V	CEANL 2R2P 50
C3	Ceramic	100p	50V	CCDSL 101K 50
C4	Ceramic	100p	50V	CCDSL 101K 50
C5	Electrolytic	4.7	35V	CEANL 4R7P 35
C6	Electrolytic	4.7	35V	CEANL 4R7P 35
C7	Electrolytic	2.2	50V	CEANL 2R2P 50
C8	Electrolytic	2.2	50V	CEANL 2R2P 50
C9	Ceramic	100p	50V	CCDSL 101K 50
C10	Ceramic	100p	50V	CCDSL 101K 50
C11	Electrolytic	4.7	35V	CEANL 4R7P 35
C12	Electrolytic	4.7	35V	CEANL 4R7P 35
C13	Electrolytic	0.22	35V	CSZA R22M 35
C14	Electrolytic	0.22	35V	CSZA R22M 35
C15	Electrolytic	0.22	35V	CSZA R22M 35
C16	Electrolytic	0.22	35V	CSZA R22M 35
C17	Electrolytic	0.1	35V	CSZA 0R1M 35
C18	Electrolytic	0.1	35V	CSZA 0R1M 35
C19	Electrolytic	0.1	35V	CSZA 0R1M 35
C20	Electrolytic	0.1	35V	CSZA 0R1M 35
C21	Mylar	0.0027	50V	QOMA 272J 50
C22	Mylar	0.0027	50V	QOMA 272J 50
C23	Mylar	0.0047	50V	QOMA 472J 50
C24	Mylar	0.0047	50V	QOMA 472J 50
C25	Mylar	0.0056	50V	QOMA 562J 50
C26	Mylar	0.0056	50V	QOMA 562J 50
C27	Mylar	0.0082	50V	QOMA 822J 50
C28	Mylar	0.0082	50V	QOMA 822J 50
C29	Electrolytic	2.2	50V	CEANL 2R2P 50
C30	Electrolytic	2.2	50V	CEANL 2R2P 50
C31	Ceramic	100p	50V	CCDSL 101K 50
C32	Ceramic	100p	50V	CCDSL 101K 50
C33	Electrolytic	4.7	35V	CEANL 4R7P 35
C34	Electrolytic	4.7	35V	CEANL 4R7P 35
C35	Electrolytic	4.7	35V	CEANL 4R7P 35
C36	Electrolytic	10	25V	CEANL 100P 25
C37	Ceramic	100p	50V	CCDSL 101K 50
C38	Ceramic	100p	50V	CCDSL 101K 50

## RESISTORS

Symbol	Description	Part No.
VR1	Variable resistor 50k-AC (BALANCE)	ACV-145-0
R1	Carbon film 2.2k	RD%PS 222J
R2	Carbon film 2.2k	RD%PS 222J
R3	Carbon film 120k	RD%PS 124J
R4	Carbon film 120k	RD%PS 124J
R5	Carbon film 470	RD%PS 471J
R6	Carbon film 470	RD%PS 471J
R7	Carbon film 180k	RD%PS 184J
R8	Carbon film 180k	RD%PS 184J
R9	Carbon film 180k	RD%PS 184J
R10	Carbon film 180k	RD%PS 184J
R11	Carbon film 20k	RD%PS 203J
R12	Carbon film 20k	RD%PS 203J
R13	Carbon film 22k	RD%PS 223J
R14	Carbon film 22k	RD%PS 223J
R15	Carbon film 5.1k	RD%PS 512J
R16	Carbon film 5.1k	RD%PS 512J
R17	Carbon film 750	RD%PS 751J
R18	Carbon film 750	RD%PS 751J
R19	Carbon film 1k	RD%PS 102J
R20	Carbon film 1k	RD%PS 102J
R21	Carbon film 180k	RD%PS 184J
R22	Carbon film 180k	RD%PS 184J
R23	Carbon film 180k	RD%PS 184J
R24	Carbon film 180k	RD%PS 184J
R25	Carbon film 15k	RD%PS 153J
R26	Carbon film 15k	RD%PS 153J
R27	Carbon film 220k	RD%PS 224J
R28	Carbon film 220k	RD%PS 224J
R29	Carbon film 3.3k	RD%PS 332J
R30	Carbon film 3.3k	RD%PS 332J
R31	Carbon film 47k	RD%PS 473J
R32	Carbon film 47k	RD%PS 473J
R33	Carbon film 3.3k	RD%PS 332J
R34	Carbon film 3.3k	RD%PS 332J
R35	Carbon film 430k	RD%PS 434J
R36	Carbon film 430k	RD%PS 434J
R37	Carbon film 470	RD%PS 471J
R38	Carbon film 470	RD%PS 471J
R39	Carbon film 220k	RD%PS 224J
R40	Carbon film 220k	RD%PS 224J
R41	Carbon film 220k	RD%PS 224J
R42	Carbon film 220k	RD%PS 224J
R43	Carbon film 10k %W	RD%PS 103J
R44	Carbon film 10k %W	RD%PS 103J
R45	Carbon film 470k	RD%PS 474J

Continued on the Next Page

Symbol	Description	Part No.
R46	Carbon film 470k	RD%PS 474J
R47	Carbon film 47k	RD%PS 473J
R48	Carbon film 47k	RD%PS 473J
R49	Carbon composition 200M	ACN-001-0
R50	Carbon composition 200M	ACN-001-0
R51	Carbon film 1k	RD%PS 102J
R52	Carbon film 1k	RD%PS 102J
R53	Carbon film 8.2k	RD%PS 822J
R54	Carbon film 8.2k	RD%PS 822J
R55	Carbon film 10k	RD%PS 103J
R56	Carbon film 10k	RD%PS 103J

### SEMICONDUCTORS

Symbol	Description	Part No.
Q1	Transistor 2SC1451P-V or S	
Q2	Transistor 2SC1451P-V or S	
Q3	Transistor 2SC1451P-V, B or S	
Q4	Transistor 2SC1451P-V, B or S	
Q5	Transistor 2SC1451P-V, B or S	
Q6	Transistor 2SC1451P-V or S	
Q7	Transistor 2SK30A-Y or GR	
Q8	Transistor 2SK30A-Y or GR	

### SWITCHES

Symbol	Description	Part No.
S1	Rotary switch (MODE)	ASD-020-A
S2	Lever switch (ATTENUATOR)	ASK-087-A
S3	Lever switch (LOW FILTER)	ASK-085-0
S4	Lever switch (HIGH FILTER)	ASK-085-0
S5	Lever switch (TONE)	ASK-091-A

### OTHERS

Symbol	Description	Part No.
	Nut (9ø)	B71-004-0
	Internal lock washer	ABE-001-0
	Screw	ABA-002-0

## 11. PACKING METHOD

